

BREMAK[®]



**CATALOGO
GENERALE**

16



BREMAK®

N° 16

BREMAK Stl. è una società familiare fondata nel 2010, specializzata nella distribuzione di articoli innovativi e di alta qualità rivolti principalmente a ferramente, utensilerie, rivenditori edili, autoricambi e colorifici.

Grazie alla sua esperienza riesce a diventare per i propri clienti un valido supporto per la ricerca di articoli speciali, seguendoli a 360°.

I principali punti di forza che la contraddistinguono sono:

Innovazione:

Tramite una costante ricerca su scala internazionale riesce a proporre le ultime novità presenti nel mercato.

Qualità:

I prodotti proposti vengono testati in fase di inserimento in modo da offrire alla clientela degli standard elevati.

Servizio:

L'ordine viene evaso nelle 24 ore successive

SCONTO

SPESE DI TRASPORTO

SU IMPONIBILE

CONDIZIONI GENERALI DI VENDITA

- Eventuali reclami devono essere fatti entro 8 giorni dal ricevimento della merce
- Non si accettano resi se non autorizzati dalla sede
- La merce viaggia sempre a rischio e pericolo del committente
- Per contestazioni è competente il foro di Treviso.

L'azienda Bremak S.r.l. declina ogni responsabilità relativa all'utilizzo e montaggio errato o inappropriato dei prodotti presenti all'interno di questo catalogo. I disegni, le dimensioni e le confezioni sono indicative, soggetti a tolleranze di lavorazione e possono essere variati per esigenze produttive fino ad esaurimento, potranno essere spedite confezioni diverse da quelle descritte nel presente catalogo. L'azienda Bremak S.r.l. si riserva la possibilità di cambiare, modificare o eliminare prodotti da questo catalogo senza preavviso.

ABRASIVI

7-19



CHIMICO

20-27



TAGLIO E FLESSOMETRI

28-47



LAMPADE

48-55



ANTINFORTUNISTICA

56-85



EDILIZIA

86-108



UTENSILERIA

109-137



SPOSTA OGGETTI

138-143



RIVETTI

144-149



FILIERE ESTRATTORI E LIME

150-155



PUNTE

156-174



FASCETTE

176-191



VITERIA

192-194





ABRASIVI

Disco diamantato exclusive

taglio e sbavatura



NEW

100% BEST QUALITY

CODICE	DESCRIZIONE	Q.TÀ
C4858	Ø115x1,2 mm	10
C4859	Ø125x1,2 mm	10

Disco diamantato exclusive



CODICE	DESCRIZIONE	Q.TÀ
C4850	Ø115x1,2 mm	10
C4851	Ø125x1,3 mm	10
C4853	Ø230x2 mm	10

Disco diamantato

taglio metallo



CODICE	DESCRIZIONE	Q.TÀ
C4750	Ø115 mm	10
C4751	Ø125 mm	10

Disco diamantato

per cemento armato



CODICE	DESCRIZIONE	Q.TÀ
C4677	Ø115 mm	10
C4678	Ø125 mm	10
C4679	Ø180 mm	10
C4680	Ø230 mm	10

Disco in diamante

per asfalto, taglio a secco e umido



CODICE	DESCRIZIONE	Q.TÀ
C4697	300x25,4/20	10
C4898	350x25,4/20	10
C4899	400x25,4/20	10

Disco diamantato

taglio e levigatura



CODICE	DESCRIZIONE	Q.TÀ
C4894	300x25,4/20	10
C4895	350x25,4/20	10
C4896	400x25,4/20	10

Disco diamantato

taglio piastrelle, gres, cemento, marmo



CODICE	DESCRIZIONE	Q.TÀ
C4861	180x25,4/22,23	10
C4862	200x25,4/22,23	10
C4864	230x25,4/22,23	10
C4865	250x25,4/22,23	10

Disco diamantato

taglio acciaio



NEW

CODICE	DESCRIZIONE	Q.TÀ
CXT163115	Ø115x1,2x22,2 mm	10
CXT163125	Ø125x1,2x22,2 mm	10

Disco diamantato

taglio legno

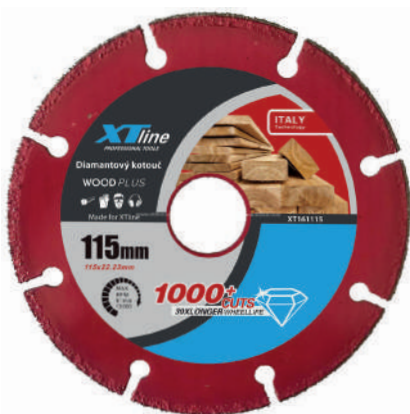

NEW

CODICE	DESCRIZIONE	Q.TÀ
CXT161115	Ø115x1,2x22,2 mm	10
CXT161125	Ø125x1,2x22,2 mm	10

Disco diamantato

taglio pietra, legno, acciaio



NEW

CODICE	DESCRIZIONE	Q.TÀ
CXT162115	Ø115x1,2x22,2 mm	10
CXT162125	Ø125x1,2x22,2 mm	10

Disco diamantato

taglio e levigatura piastrelle in gres

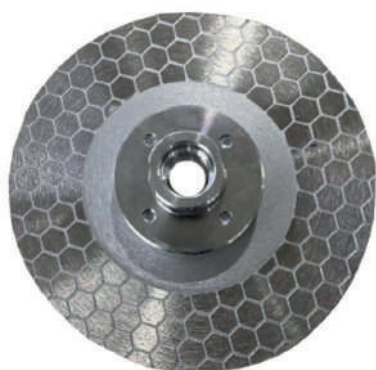

NEW

2 IN 1 M14

CODICE	DESCRIZIONE	Q.TÀ
C4860	Ø125x1,6x25 mm	10

Platello diamantato TURBO

anche per metalli costosi



NEW

CODICE	DESCRIZIONE	Q.TÀ
CHBL115	Ø115 mm	10
C4691	Ø125 mm	10

Platorello diamantato

doppia corona



CODICE	DESCRIZIONE	Q.TÀ
C4686	Ø125 mm	10

Platorello diamantato a "L"

anche per metalli colosi



CODICE	DESCRIZIONE	Q.TÀ
C4696	"L" Ø125 mm	6

Disco diamantato segmentato

taglio cemento, granito, pietra



CODICE	DESCRIZIONE	Q.TÀ
C4800	Ø115x2x22,2	10
C4801	Ø125x2x22,2	10
C4803	Ø230x2,4x22,2	10

Disco diamantato taglio TURBO

taglio rapido cemento, granito, pietra



CODICE	DESCRIZIONE	Q.TÀ
C4808	Ø115x2x22,2 mm	10
C4809	Ø125x2x22,2 mm	10
C4811	Ø230x2x22,2 mm	10

Disco diamantato corona liscia

taglio ceramica, piastrelle, vetro



CODICE	DESCRIZIONE	Q.TÀ
C4804	Ø115x2x22,2 mm	10
C4805	Ø125x2x22,2 mm	10
C4807	Ø230x2,4x22,2 mm	10

Disco diamantato SUPER TURBO

taglio rapido cemento, granito, pietra



CODICE	DESCRIZIONE	Q.TÀ
C4812	Ø115x2x22,2 mm	10
C4813	Ø125x2x22,2 mm	10
C4815	Ø230x2x22,2 mm	10

Frese carotatrici diamantate

taglio acciaio M14



CODICE	DESCRIZIONE	Q.TÀ
C4816	6 mm	1
C4817	8 mm	1
C4818	10 mm	1
C4819	12 mm	1
C4822	16 mm	1
C4824	20 mm	1
C4826	25 mm	1
C4829	30 mm	1
C4831	35 mm	1
C4834	45 mm	1
C4835	50 mm	1
C4837	55 mm	1
C4840	68 mm	1
C4844	82 mm	1

Set frese carotatrici diamantate



CODICE	DESCRIZIONE	Q.TÀ
C4848	6, 8, 10, 20, 30, 35, 50, 68 mm	1

Punta crotatrice diamantata qualità industriale

PREMIUM QUALITY

CODICE	DESCRIZIONE	Q.TÀ
C4866	16x400 1/2	1
C4867	18x400 1/2	1
C4868	20x400 1/2	1
C4869	22x400 1/2	1
C4870	24x400 1/2	1
C4871	25x400 1/2	1
C4872	26x400 1/2	1
C4873	28x400 1/2	1
C4874	30x400 1/2	1
C4875	32x400 1/2	1
C4876	35x400 1/2	1
C4877	40x400 1/2	1
C4878	42x400 1/2	1
C4879	52x450 1/4	1

CODICE	DESCRIZIONE	Q.TÀ
C4880	62x450 1/4	1
C4881	72x450 1/4	1
C4882	82x450 1/4	1
C4883	102x450 1/4	1
C4884	112x450 1/4	1
C4885	122x450 1/4	1
C4886	132x450 1/4	1
C4887	142x450 1/4	1
C4888	152x450 1/4	1
C4889	162x450 1/4	1
C4890	182x450 1/4	1
C4891	200x450 1/4	1
C4892	225x450 1/4	1
C4893	250x450 1/4	1



Prolunga per carotatrice diamantata



CODICE	DESCRIZIONE	Q.TÀ
C8265	300 mm 1/4	1
C8266	500 mm 1/4	1

Prolunga per carotatrice diamantata



CODICE	DESCRIZIONE	Q.TÀ
C8267	300 mm R 1/2'	1
C8268	500 mm R 1/2'	1

Adattatore



CODICE	DESCRIZIONE	Q.TÀ
C8270	1/4' + R 1/2'	1

Adattatore HILTI BI+



CODICE	DESCRIZIONE	Q.TÀ
C8271	1/4' + R 1/2'	1

Adattatore HILTI BU



CODICE	DESCRIZIONE	Q.TÀ
C8272	1/4' + R 1/2'	1

Adattatore HILTI BL



CODICE	DESCRIZIONE	Q.TÀ
C8273	1/4' + R 1/2'	1

Disco smeriglio
legno, plastica e cartongesso



NEW

CODICE	DESCRIZIONE	Q.TÀ
CXT164121	Ø125x3x22,2 mm FINE	10
CXT164122	Ø125x3x22,2 mm MEDIO	10
CXT164123	Ø125x3x22,2 mm GROSSO	10

10 dischi
professional top INOX



CODICE	DESCRIZIONE	Q.TÀ
1001111246X10	Ø115x1x22,20 mm PIANO	10
1001111250X10	Ø115x1.6x22,20 mm PIANO	10

Disco
taglio alluminio



CODICE	DESCRIZIONE	Q.TÀ
1001111150	Ø115x1,2x22,20 mm PIANO	50
1001121150	Ø125x1,2x22,20 mm PIANO	50
1001233150	Ø230x1,9x22,20 mm DEPRESSO	50

Fresa diamantata a cono



NEW

M14

CODICE	DESCRIZIONE	Q.TÀ
C4849	10X50 mm	10
C4846	25X50 mm	10

Disco
INOX standard



CODICE	DESCRIZIONE	Q.TÀ
1001111247	Ø115x1x22,20 mm PIANO	50
1001111251	Ø115x1,6x22,20 mm PIANO	50
1001111252	Ø115x1,9x22,20 mm PIANO	50

Disco
multiuniversale



CODICE	DESCRIZIONE	Q.TÀ
1001111360	Ø115x1,2x22,20 mm PIANO	50
1001121360	Ø125x1,2x22,20 mm PIANO	50
1001233360	Ø230x1,9x22,20 mm DEPRESSO	50

Disco
taglio legno



CODICE	DESCRIZIONE	Q.TÀ
1001111300	Ø115x1.6x22,20 mm PIANO	10
1001233300	Ø230x2x22,20 mm PIANO	10

Disco
taglio pietra e marmo



CODICE	DESCRIZIONE	Q.TÀ
1001115000	Ø115x1,6x22,20 mm PIANO	50
1001117015	Ø115x3,2x22,20 mm DEPRESSO	50
1001125000	Ø125x1,6x22,20 mm PIANO	50
1001127015	Ø125x3,2x22,20 mm DEPRESSO	50
1001238250	Ø230x1,9x2,20 PIANO	50
1001237015	Ø230x3,2x22,20 mm DEPRESSO	50

Disco top INOX



CODICE	DESCRIZIONE	Q.TÀ
1001111000	Ø115x0,8x22,20 mm PIANO	100
1001111246	Ø115x1x22,20 mm PIANO	100
1001111250	Ø115x1,6x22,20 mm PIANO	100
1001113906	Ø115x2,5x22,20 mm DEPRESSO	50
1003116500	Ø115x6x22,20 mm DEPRESSO	25
1001121000	Ø125x0,8x22,20 mm PIANO	50
1001121246	Ø125x1x22,20 mm PIANO	50
1001121250	Ø125x1,6x22,20 mm PIANO	50
1001123906	Ø125x2,5x22,20 mm DEPRESSO	50
1003126500	Ø125x6x22,20 mm DEPRESSO	25
1001233251	Ø230x1,9x22,20 mm PIANO	50
1001232015	Ø230x3x22,20 mm DEPRESSO	50
1003236500	Ø230x6x22,20 mm DEPRESSO	25

Disco lamellare
corindone-zirconio



CODICE	DESCRIZIONE	Q.TÀ
1005211183	ZIRCONIO Ø115x22,20 mm 36 gr PIANO	20
1005211184	ZIRCONIO Ø115x22,20 mm 40 gr PIANO	20
1005211186	ZIRCONIO Ø115x22,20 mm 60 gr PIANO	20
1005211187	ZIRCONIO Ø115x22,20 mm 80 gr PIANO	20
1005211188	ZIRCONIO Ø115x22,20 mm 100 gr PIANO	20
1005211189	ZIRCONIO Ø115x22,20 mm 120 gr PIANO	20
1005212184	ZIRCONIO Ø125x22,20 mm 40 gr PIANO	20
1005212186	ZIRCONIO Ø125x22,20 mm 60 gr PIANO	20
1005212187	ZIRCONIO Ø125x22,20 mm 80 gr PIANO	20
1005212188	ZIRCONIO Ø125x22,20 mm 100 gr PIANO	20
1005212189	ZIRCONIO Ø125x22,20 mm 120 gr PIANO	20
10068051509	CORINDONE Ø115x22,20 mm 40 gr PIANO	20
10068051511	CORINDONE Ø115x22,20 mm 60 gr PIANO	20
10068051512	CORINDONE Ø115x22,20 mm 80 gr PIANO	20
10068051513	CORINDONE Ø115x22,20 mm 100 gr PIANO	20
10068051514	CORINDONE Ø115x22,20 mm 120 gr PIANO	20

Disco FLEXTRON

semiflessibile



CODICE	DESCRIZIONE	Q.TÀ
C4660	Ø125 mm 16 gr	25
C4661	Ø125 mm 24 gr	25
C4662	Ø125 mm 36 gr	25
C4663	Ø125 mm 40 gr	25
C4664	Ø125 mm 60 gr	25
C4665	Ø125 mm 80 gr	25
C4666	Ø125 mm 100 gr	25
C4667	Ø125 mm 120 gr	50

Ruota lamellare

con gambo



CODICE	DESCRIZIONE	Q.TÀ
C4360	GAMBO 6 mm SPESSORE 20 mm Ø20 mm 40 gr	10
C4361	GAMBO 6 mm SPESSORE 20 mm Ø20 mm 60 gr	10
C4362	GAMBO 6 mm SPESSORE 20 mm Ø20 mm 80 gr	10
C4363	GAMBO 6 mm SPESSORE 20 mm Ø20 mm 100 gr	10
C4364	GAMBO 6 mm SPESSORE 20 mm Ø20 mm 120 gr	10
C4370	GAMBO 6 mm SPESSORE 15 mm Ø30 mm 40 gr	10
C4371	GAMBO 6 mm SPESSORE 15 mm Ø30 mm 60 gr	10
C4372	GAMBO 6 mm SPESSORE 15 mm Ø30 mm 80 gr	10
C4373	GAMBO 6 mm SPESSORE 15 mm Ø30 mm 100 gr	10
C4374	GAMBO 6 mm SPESSORE 15 mm Ø30 mm 120 gr	10
C4375	GAMBO 6 mm SPESSORE 20 mm Ø40 mm 40 gr	10
C4376	GAMBO 6 mm SPESSORE 20 mm Ø40 mm 60 gr	10
C4377	GAMBO 6 mm SPESSORE 20 mm Ø40 mm 80 gr	10
C4378	GAMBO 6 mm SPESSORE 20 mm Ø40 mm 100 gr	10
C4379	GAMBO 6 mm SPESSORE 20 mm Ø40 mm 120 gr	10
C4380	GAMBO 6 mm SPESSORE 20 mm Ø50 mm 40 gr	10
C4381	GAMBO 6 mm SPESSORE 20 mm Ø50 mm 60 gr	10
C4382	GAMBO 6 mm SPESSORE 20 mm Ø50 mm 80 gr	10
C4383	GAMBO 6 mm SPESSORE 20 mm Ø50 mm 100 gr	10
C4384	GAMBO 6 mm SPESSORE 20 mm Ø50 mm 120 gr	10
C4385	GAMBO 6 mm SPESSORE 20 mm Ø60 mm 40 gr	10
C4386	GAMBO 6 mm SPESSORE 20 mm Ø60 mm 60 gr	10
C4387	GAMBO 6 mm SPESSORE 20 mm Ø60 mm 80 gr	10
C4388	GAMBO 6 mm SPESSORE 20 mm Ø60 mm 100 gr	10
C4389	GAMBO 6 mm SPESSORE 20 mm Ø60 mm 120 gr	10

Disco tela
per pulitura

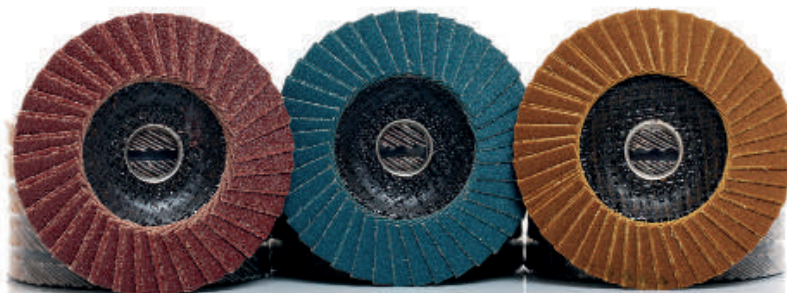

100% BEST QUALITY

CODICE	DESCRIZIONE	Q.TÀ
1005511204	Ø115 mm PASTA GROSSA	10
1005511206	Ø115 mm PASTA MEDIA	10
1005511207	Ø115 mm PASTA FINE	10

Disco
per lucidare



CODICE	DESCRIZIONE	Q.TÀ
1005511220	Ø115 mm FINISH LAMELLARE	10

Ruota lamellare in feltro



CODICE	DESCRIZIONE	Q.TÀ
100FLP30	Ø30 mm	10
100FLP40	Ø40 mm	10
100FLP50	Ø50 mm	10
100FLP60	Ø60 mm	10
100FLP80	Ø80 mm	10

Pasta
per lucidatura

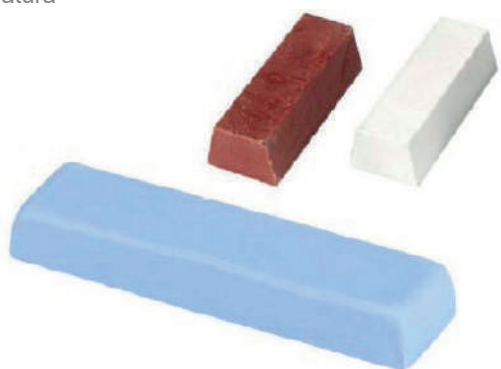

CODICE	DESCRIZIONE	Q.TÀ
1006400402	COLORE MARRONE 110GR	10
1006400403	COLORE BIANCA 110GR	10
1006400404	COLORE BLU 110GR	10

Set lucidatura 3 dischi lamellari

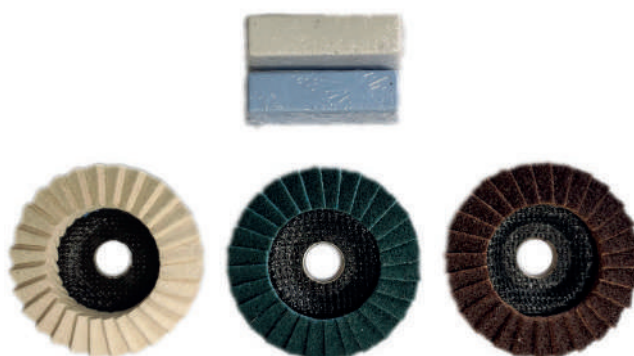

CODICE	DESCRIZIONE	Q.TÀ
1006900040	SET 3 DISCHI LAMELLARI Ø115 mm+2 PASTE	10



Spazzola a tazza
con attacco M14



CODICE	DESCRIZIONE	Q.TÀ
C4304	Ø75 mm	6
C4305	Ø100 mm	6

Spazzola conica
con attacco M14



CODICE	DESCRIZIONE	Q.TÀ
C4303	Ø100 mm	6

Spazzola circolare filo ritorto
con attacco M14

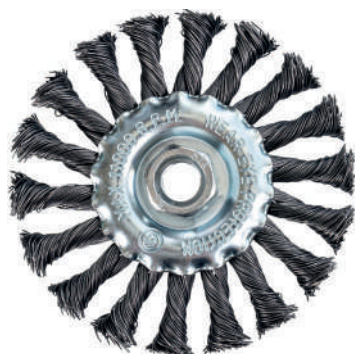

CODICE	DESCRIZIONE	Q.TÀ
C4309	Ø100 mm	6
C4310	Ø115 mm	6
C4311	Ø125 mm	6

Spazzola conica filo ritorto
con attacco M14



CODICE	DESCRIZIONE	Q.TÀ
C4312	Ø100 mm	6

Spazzola a tazza filo ritorto

con attacco M14



CODICE	DESCRIZIONE	Q.TÀ
C4306	Ø65 mm	6
C4307	Ø80 mm	6
C4308	Ø100 mm	6

Spazzola circolare

con perno



CODICE	DESCRIZIONE	Q.TÀ
C4314	Ø50 mm	6
C4315	Ø63 mm	6
C4316	Ø75 mm	6
C4317	Ø100 mm	6

Spazzola a tazza

con perno



CODICE	DESCRIZIONE	Q.TÀ
C4318	Ø65 mm	6
C4319	Ø75 mm	6

Spazzola a pennello

con perno



CODICE	DESCRIZIONE	Q.TÀ
C4323	Ø12 mm	6
C4324	Ø17 mm	6
C4325	Ø25 mm	6

Spazzola circolare filo ritorto

con perno



CODICE	DESCRIZIONE	Q.TÀ
C4320	Ø75 mm	6

Spazzola conica filo ritorto

con perno



CODICE	DESCRIZIONE	Q.TÀ
C4321	Ø75 mm	6

Spazzola a tazza filo ritorto
con perno



CODICE	DESCRIZIONE	Q.TÀ
C4322	Ø75 mm	6

Foglio abrasivo
in ossido di alluminio



CODICE	DESCRIZIONE	Q.TÀ
YT-8360	PS30D H.115x50 mt 40 gr	50
YT-8361	PS30D H.115x50 mt 60 gr	50
YT-8363	PS30D H.115x50 mt 80 gr	50
YT-8362	PS30D H.115x50 mt 100 gr	50
YT-8364	PS30D H.115x50 mt 120 gr	50
YT-8365	PS30D H.115x50 mt 150 gr	50
YT-8366	PS30D H.115x50 mt 180 gr	50
YT-8367	PS30D H.115x50 mt 240 gr	50
YT-8368	PS30D H.115x50 mt 280 gr	50

Spazzola
con filo acciaio e INOX



CODICE	DESCRIZIONE	Q.TÀ
C4354	CON FILO OTTONE LUNGHEZZA 240 mm	6
C4355	CON FILO INOX LUNGHEZZA 240 mm	6

Disco abrasivo



CODICE	DESCRIZIONE	Q.TÀ
YT-83430	Ø125 mm 36 gr CONFEZIONE DA 5PZ	50
YT-83431	Ø125 mm 40 gr CONFEZIONE DA 5PZ	50
YT-83432	Ø125 mm 60 gr CONFEZIONE DA 5PZ	50
YT-83433	Ø125 mm 80 gr CONFEZIONE DA 5PZ	50
YT-83434	Ø125 mm 100 gr CONFEZIONE DA 5PZ	50
YT-83435	Ø125 mm 120 gr CONFEZIONE DA 5PZ	50
YT-83436	Ø125 mm 150 gr CONFEZIONE DA 5PZ	50
YT-83437	Ø125 mm 180 gr CONFEZIONE DA 5PZ	50
YT-83438	Ø125 mm 220 gr CONFEZIONE DA 5PZ	50

Disco abrasivo con fori



CODICE	DESCRIZIONE	Q.TÀ
YT-83440	Ø115 mm 36 gr CONFEZIONE DA 5PZ	50
YT-83441	Ø115 mm 40 gr CONFEZIONE DA 5PZ	50
YT-83442	Ø115 mm 60 gr CONFEZIONE DA 5PZ	50
YT-83443	Ø115 mm 80 gr CONFEZIONE DA 5PZ	50
YT-83444	Ø115 mm 100 gr CONFEZIONE DA 5PZ	50
YT-83445	Ø115 mm 120 gr CONFEZIONE DA 5PZ	50
YT-83446	Ø115 mm 150 gr CONFEZIONE DA 5PZ	50
YT-83447	Ø115 mm 180 gr CONFEZIONE DA 5PZ	50
YT-83448	Ø115 mm 220 gr CONFEZIONE DA 5PZ	50

CODICE	DESCRIZIONE	Q.TÀ
YT-83451	Ø125 mm 40 gr CONFEZIONE DA 5PZ	50
YT-83452	Ø125 mm 60 gr CONFEZIONE DA 5PZ	50
YT-83453	Ø125 mm 80 gr CONFEZIONE DA 5PZ	50
YT-83454	Ø125 mm 100 gr CONFEZIONE DA 5PZ	50
YT-83455	Ø125 mm 120 gr CONFEZIONE DA 5PZ	50
YT-83456	Ø125 mm 150 gr CONFEZIONE DA 5PZ	50
YT-83457	Ø125 mm 180 gr CONFEZIONE DA 5PZ	50
YT-83458	Ø125 mm 220 gr CONFEZIONE DA 5PZ	50

Platorello

con attacco in veltro



CODICE	DESCRIZIONE	Q.TÀ
C4670	Ø115 mm	10
C4671	Ø125 mm	10
C4672	Ø155 mm	10

Supporto in plastica



CODICE	DESCRIZIONE	Q.TÀ
C4668	Ø125 mm	6

Spugne abrasive



CODICE	DESCRIZIONE	Q.TÀ
C4790	100x70x25 mm 36 gr	25
C4791	100x70x25 mm 46 gr	25
C4792	100x70x25 mm 60 gr	25
C4793	100x70x25 mm 80 gr	25
C4794	100x70x25 mm 100 gr	25
C4795	100x70x25 mm 120 gr	25
C4796	100x70x25 mm 150 gr	25
C4797	100x70x25 mm 180 gr	25
C4798	100x70x25 mm 220 gr	25



Carta abrasiva

in ossido di alluminio



CODICE	DESCRIZIONE	Q.TÀ
YT-8458	PS30D H.115X50 mt 40 gr	12
YT-8459	PS30D H.115X50 mt 60 gr	12
YT-8460	PS30D H.115X50 mt 80 gr	12
YT-8461	PS30D H.115X50 mt 100 gr	12
YT-8462	PS30D H.115X50 mt 120 gr	12
YT-8463	PS30D H.115X50 mt 150 gr	12
YT-8464	PS30D H.115X50 mt 180 gr	12
YT-8465	PS30D H.115X50 mt 240 gr	12
YT-8466	PS30D H.115X50 mt 280 gr	12
YT-8467	PS30D H.115X50 mt 320 gr	12
YT-8440	PS30D H.115X5 mt 40 gr	12
YT-8441	PS30D H.115X5 mt 60 gr	12
YT-8442	PS30D H.115X5 mt 80 gr	12
YT-8443	PS30D H.115X5 mt 100 gr	12
YT-8444	PS30D H.115X5 mt 120 gr	12
YT-8445	PS30D H.115X5 mt 150 gr	12
YT-8446	PS30D H.115X5 mt 180 gr	12
YT-8447	PS30D H.115X5 mt 240 gr	12
YT-8448	PS30D H.115X5 mt 320 gr	12



CHIMICO

Pistola per silicone
in polipropene copolimero

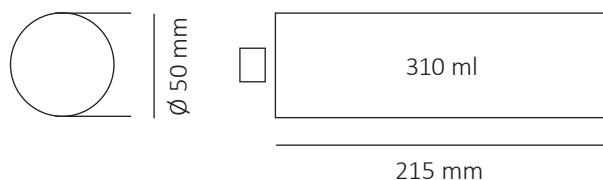
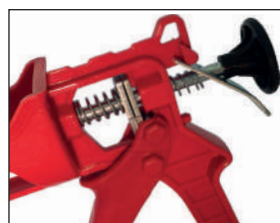

RAPPORTO SPINTA 29:1

CODICE	DESCRIZIONE	Q.TÀ
BK8001	PISTOLA IN POLIPROPILENE COPOLIMERO	15

Pistola per silicone
in alluminio SILITEK

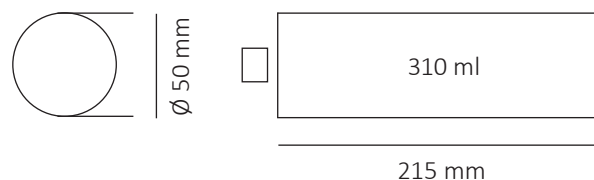

RAPPORTO SPINTA 29:1

CODICE	DESCRIZIONE	Q.TÀ
BK8010	PISTOLA SILICONE IN ALLUMINIO	15

Pistola per silicone
a stelo professionale tipo COX

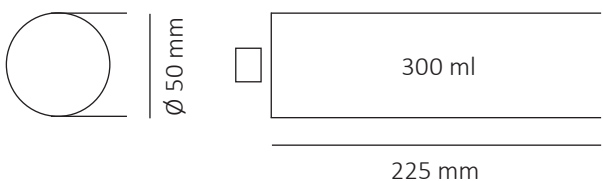

CODICE	DESCRIZIONE	Q.TÀ
C8003	PISTOLA PER SILICONE TIPO COX	25

Pistola per silicone
a tre steli professionale

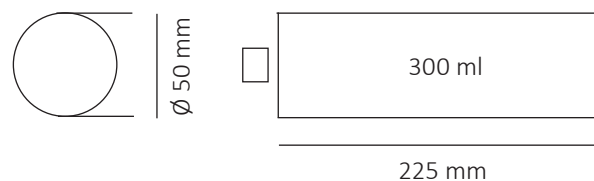

CODICE	DESCRIZIONE	Q.TÀ
C8007	PISTOLA A TRE STELI PROFESSIONALE	12

Pistola per silicone

con tubo professionale in alluminio

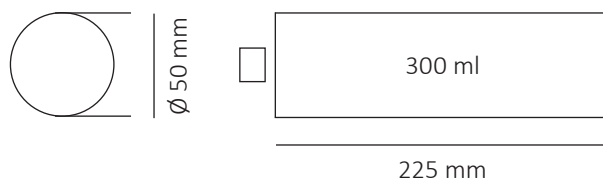

RAPPORTO SPINTA 29:1

CODICE	DESCRIZIONE	Q.TÀ
BK8050	400 MI	12
BK8055	600 MI	12

Pistola per silicone

in acciaio

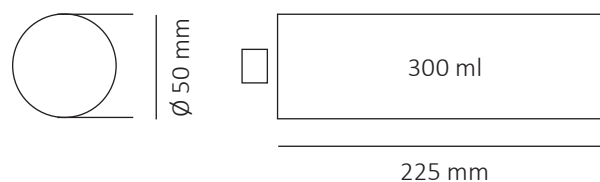

CODICE	DESCRIZIONE	Q.TÀ
C8004	PISTOLA PER SILICONE	25

Pistola per chimico

bi-componente in alluminio

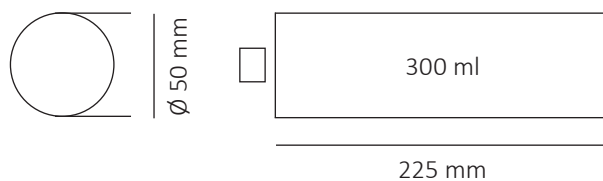

RAPPORTO SPINTA 29:1

CODICE	DESCRIZIONE	Q.TÀ
BK8020	PISTOLA PER CHIMICO IN ALLUMINIO	12

Pistola per chimico

per masse spesse

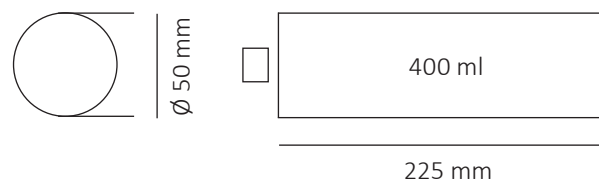

NEW

CODICE	DESCRIZIONE	Q.TÀ
C8012	400 MI	25

Pistola per silicone/chimico
Raptor

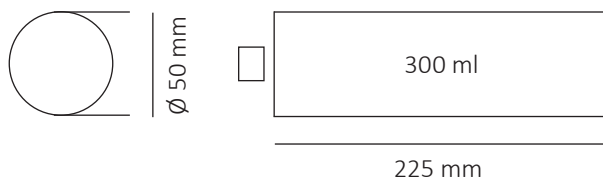

RAPPORTO SPINTA 29:1

CODICE	DESCRIZIONE	Q.TÀ
BK8045	PISTOLA CHIMICO 400ml RAPTOR PLUS	12

Pistola per chimico
Raptor plus

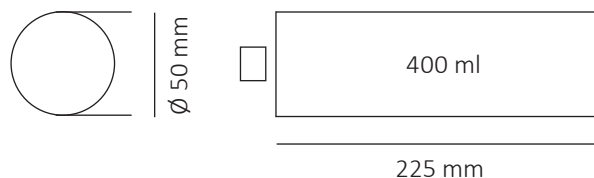

RAPPORTO SPINTA 29:1

CODICE	DESCRIZIONE	Q.TÀ
BK8040	PISTOLA SILICONE/CHIMICO RAPTOR	12



**PISTOLE
SILICONE/CHIMICO
RAPTOR**

RAPPORTO SPINTA 29:1



Pistola per chimico
in alluminio

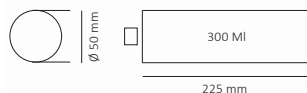

RAPPORTO SPINTA 29:1

CODICE	DESCRIZIONE	Q.TÀ
BK8025	400 MI	20

Pistola per schiuma poliuretanica
tutta in TEFLON professionale



CODICE	DESCRIZIONE	Q.TÀ
C8025	IN TEFLON PROFESSIONALE	20

Pistola per schiuma PREMIUM QUALITY
in TEFLON ottone con microregolazione ultrasensibile



CODICE	DESCRIZIONE	Q.TÀ
C8026	PISTOLA SCHIUMA	20

Pistola lunga per schiuma
500 mm



PTFE

CODICE	DESCRIZIONE	Q.TÀ
YT-67460	500 mm	20

Pistola per schiuma poliuretanic

con testa in TEFLON



CODICE	DESCRIZIONE	Q.TÀ
C8022	PER SCHIUMA POLIURETANICA	25

Pistola per schiuma poliuretanic corta



CODICE	DESCRIZIONE	Q.TÀ
1039068	PROFESSIONALE CORTA	6

Impugnatura a pistola

per bombolette spray



CODICE	DESCRIZIONE	Q.TÀ
103BK001	PER BOMBOLETTE SPRAY (AEROSOL)	24

Impugnatura a pistola

per bombolette spray unica fusione



CODICE	DESCRIZIONE	Q.TÀ
103BK002	PER BOMBOLETTE SPRAY UNICA FUSIONE	24

Pompetta aria

per pulizia di fori e tasselli



CODICE	DESCRIZIONE	Q.TÀ
BK7000	POMPETTA ARIA PULIZIA FORI TASSELLI	10

Nastro X-TREAM



CODICE	DESCRIZIONE	Q.TÀ
BLTPE-X10W	BIANCO 1"x3 MT	24
BLTPE-X10B	NERO 1"x3 MT	24

Catramina spray



100% BEST QUALITY

CODICE	DESCRIZIONE	Q.TÀ
103BK63	400 MI	12

Bitume spray



100% BEST QUALITY

CODICE	DESCRIZIONE	Q.TÀ
103BK65	400 MI	12

Grasso incolore filante



CODICE	DESCRIZIONE	Q.TÀ
103BK20	400 MI	12

Silicone spray



CODICE	DESCRIZIONE	Q.TÀ
103BK40	400 MI	12

Olio da taglio



CODICE	DESCRIZIONE	Q.TÀ
103BK60	400 MI	12

INOX spray



CODICE	DESCRIZIONE	Q.TÀ
103BK85	400 MI	12

Zinco puro



CODICE	DESCRIZIONE	Q.TÀ
103BK80	400 MI	12

Alluminio spray



CODICE	DESCRIZIONE	Q.TÀ
103BK83	400 MI	12

Rimuovi silicone professionale spray



CODICE	DESCRIZIONE	Q.TÀ
103BK45	400 MI	12

Lubrificante catene bici



CODICE	DESCRIZIONE	Q.TÀ
103BK77	200 MI	25

Multifunzione tutto in 1



CODICE	DESCRIZIONE	Q.TÀ
103BK50	400 MI	12

Detergente telaio bici



CODICE	DESCRIZIONE	Q.TÀ
103BK79	400 MI	12

Sbloccante, lubrificante, protettivo



CODICE	DESCRIZIONE	Q.TÀ
103BK30	400 MI	12

Lucidante bici



CODICE	DESCRIZIONE	Q.TÀ
103BK78	200 MI	25



UTILITY
CUTTING KNIFE
Cod.: BK9100
8 059265 552801



18 mm
Utility Knife
Maket Bıçağı
Sharp, Strong, Durable
Keskin, Güçlü, Dayanıklı



Utility Knife
Maket Bıçağı



Aluminum Body
Aluminyum Gövde



Accessories Plastics
Aksesuar Plastikleri



TAGLIO E FLESSOMETRI

Portachiavi Bremak
flessometro go mmato+stop



CODICE	DESCRIZIONE	Q.TÀ
10338008	FLESSOMETRO 1M GO mmATO + STOP	25

Portachiavi Bremak
doppio metro

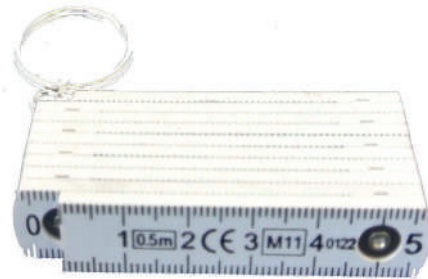

CODICE	DESCRIZIONE	Q.TÀ
10318800	DOPPIO METRO PLASTICA 0,5MT	25

Portachiavi Bremak
cutter di sicurezza



CODICE	DESCRIZIONE	Q.TÀ
10349000	CUTTER DI SICUREZZA BIANCO	25

Portachiavi Bremak
livella



CODICE	DESCRIZIONE	Q.TÀ
10333015	PORTACHIAVI BREMAK LIVELLA	25

Cutter in ABS rosso antirottura
con lama in acciaio al carbonio



CODICE	DESCRIZIONE	Q.TÀ
BK9150	CUTTER IN ABS 25 mm	24

Cutter Bremak
con lama nera SK2



ACCIAIO SK2

CODICE	DESCRIZIONE	Q.TÀ
BK9155	CUTTER LAMA NERA SK2 H 18 mm	24

Cutter Bremak in alluminio
autoretraibile



CODICE	DESCRIZIONE	Q.TÀ
BK9200	CUTTER IN ALLUMINIO AUTORETRAIBILE	12

Cutter Ninjak
con lama nera SK2



ACCIAIO SK2

CODICE	DESCRIZIONE	Q.TÀ
BK9100N	CUTTER NINJAK LAMA NERA SK2H 18 mm	24

Cutter ABS rosso
con lama nera SK2



ACCIAIO SK2

CODICE	DESCRIZIONE	Q.TÀ
BK9160	CUTTER ABS ROSSO LAMA NERA 18 mm	12

Cutter ABS rosso
con lama nera SK2-25 mm+2L



ACCIAIO SK2

CODICE	DESCRIZIONE	Q.TÀ
BK9165	CUTTER ABS ROSSO LAMA NERA 25 mm	12

Lama cutter Bremak
18-25 mm nera



CODICE	DESCRIZIONE	Q.TÀ
BK9121	LAMA CUTTER BREMAK 18 mm NERA	20
BK9122	LAMA CUTTER BREMAK 25 mm NERA	10

Cutter industriale in alluminio

lama in acciaio al carbonio



→ | ← 18MM

CODICE	DESCRIZIONE	Q.TÀ
BK9000	CUTTER IN ALLUMINIO 9 mm	30
BK9100	CUTTER IN ALLUMINIO 18 mm	24

Cutter professionale

con due lame di ricambio



ABS

CODICE	DESCRIZIONE	Q.TÀ
K960	LAMA DA 18 mm E GUIDA IN ACCIAIO	20

Cutter professionale

guida in acciaio



ABS

CODICE	DESCRIZIONE	Q.TÀ
103619-25	LAMA DA 25 mm E GUIDA IN ACCIAIO	20

Cutter con due lame

trapezio/uncino



TRAPEZOIDALE

UNCINO

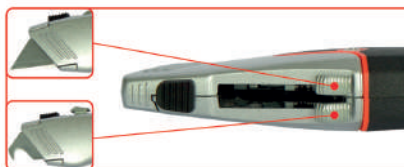

CODICE	DESCRIZIONE	Q.TÀ
BK9210	CUTTER 2LAME 61X19 mm	12

Cutter con lama trapeoidale

5 lame di ricambio



ACCIAIO SK5

CODICE	DESCRIZIONE	Q.TÀ
C9107	CUTTER CON 5 LAME DI RICAMBIO	12

Cutter in plastica



ACCIAIO SK2 ABS

CODICE	DESCRIZIONE	Q.TÀ
K250	CUTTER IN PLASTICA CON LAMA DA 9 mm	20

Cutter con lama segmentata ad uncino

impugnatura bicomponente con 4 segmenti

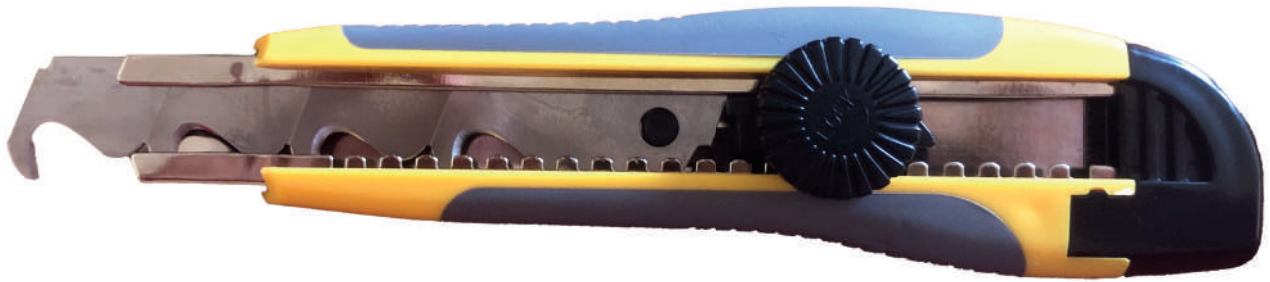

NEW

100% BEST QUALITY

18 mm

CODICE	DESCRIZIONE	Q.TÀ
103N-8	IMPUGNATURA BICOMPONENTE CON 4 SEGMENTI	12

Cutter in acciaio

18 mm



NEW

CODICE	DESCRIZIONE	Q.TÀ
C9109	CUTTER IN ACCIAIO DA 18 mm	12
YT-75123	CUTTER IN ACCIAIO DA 18 mm LAMA NERA	12

Lama di ricambio nera

per cutter



CODICE	DESCRIZIONE	Q.TÀ
C9127	LAMA DI RICAMBIO CUTTER 18 mm SK2	20

Lama di ricambio nera

per cutter ultra sharp Japan



CODICE	DESCRIZIONE	Q.TÀ
YT-75261	LAMA DI RICAMBIO CUTTER 18 mm SK2	20

Lama di ricambio CK75
per cutter



CODICE	DESCRIZIONE	Q.TÀ
BK9120	RICAMBIO CK75 PER CUTTER 18 mm CF.10	100

Lama trapezoidale
per cutter



ACCIAIO SK5

CODICE	DESCRIZIONE	Q.TÀ
C9116	LAMA TRAPEZOIDALE (10PZ)	12

Lama di ricambio
18 mm



ACCIAIO SK2

CODICE	DESCRIZIONE	Q.TÀ
C9111	LAMA DI RICAMBIO CUTTER 18 mm (10PZ)	12
C9115	LAMA DI RICAMBIO CUTTER 18 mm (10PZ) IN SK2	12

Lama di ricambio
25 mm



ACCIAIO SK5

CODICE	DESCRIZIONE	Q.TÀ
C9118	LAMA DI RICAMBIO CUTTER 25 mm (10PZ)	12

Lama a uncino
per cutter



ACCIAIO SK5

CODICE	DESCRIZIONE	Q.TÀ
C9117	LAMA TRAPEZOIDALE AD UNCINO (10PZ)	12

Forbici da elettricista
142 mm



CODICE	DESCRIZIONE	Q.TÀ
YT-1974	FORBICI DA ELETTRICISTA	12

Raschietto cutter multiuso

lama nera sk2 extra taglio, manico TPR



CODICE	DESCRIZIONE	Q.TÀ
BK9220	RASCHIETTO LAMA 18mm CORPO 30cm	6
BK9230	RASCHIETTO LAMA 25mm CORPO 60cm	6

Lama di ricambio a uncino



LAMA 19 mm

UNCINO 9 mm

CODICE	DESCRIZIONE	Q.TÀ
103R9/5	LAMA DI RICAMBIO 4 SEGMENTI	12

Lama di ricambio



0.5 mm

CODICE	DESCRIZIONE	Q.TÀ
103621	LAMA DI RICAMBIO CUTTER 9mm	12

Tagliavetro regolabile



CODICE	DESCRIZIONE	Q.TÀ
CB1000	TAGLIAVETRO REGOLABILE	12

Tagliavetro



CODICE	DESCRIZIONE	Q.TÀ
CB3200	TAGLIAVETRO	12

Lama per seghetto diamond
per metallo



CODICE	DESCRIZIONE	Q.TÀ
100BK230	BI-METAL COBALTO 8% 24TPI	100

Lama per seghetto silver
24 tipi

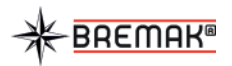

CODICE	DESCRIZIONE	Q.TÀ
100BK210	FLEXIBILE 24TPI	100

Lama per seghetto gold
per metallo



CODICE	DESCRIZIONE	Q.TÀ
100BK220	BI-METAL DENTI PROGRESSIVI 18-32TPI	100

Lama di ricambio
per metallo e legno



CODICE	DESCRIZIONE	Q.TÀ
C3391	PER METALLO LUNGHEZZA 300 mm	72
C3392	PER METALLO/LEGNO LUNGHEZZA 300 mm	72

Lama sega universale
per legno



NEW

BOX 5 pezzi 6 TPI HCS

CODICE	DESCRIZIONE	Q.TÀ
C2040	LUNGHEZZA 225 mm	10

Lama sega universale
per pallet



NEW	BOX 5 pezzi	10/14 TPI	HSS
CODICE	DESCRIZIONE	Q.TÀ	
C2043	LUNGHEZZA 225 mm	10	

Lama sega universale
per metallo



NEW	BOX 5 pezzi	24 TPI	HSS
CODICE	DESCRIZIONE	Q.TÀ	
C2049	LUNGHEZZA 150 mm	10	

Lama sega universale
per cemento

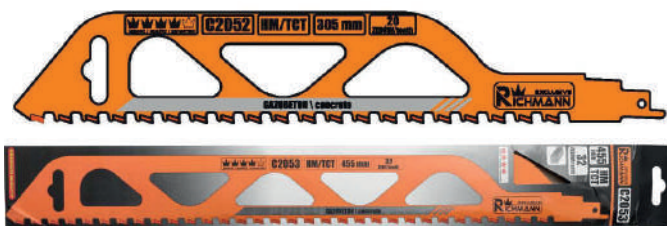

NEW	20 DENTI	HM TCT
CODICE	DESCRIZIONE	Q.TÀ
C2052	LUNGHEZZA 305 mm	10

Lama sega universale
per metallo



NEW	BOX 5 pezzi	14 TPI	HSS
CODICE	DESCRIZIONE	Q.TÀ	
C2048	LUNGHEZZA 150 mm	10	
C2050	LUNGHEZZA 225 mm	10	

Lama sega universale
per cemento

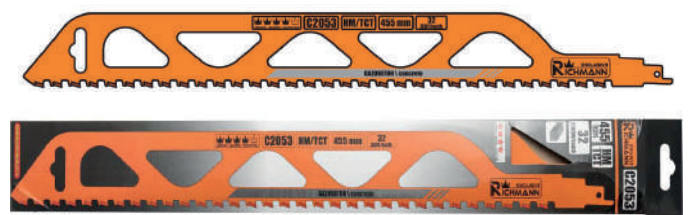

NEW	32DENTI	HM TCT
CODICE	DESCRIZIONE	Q.TÀ
C2053	LUNGHEZZA 455 mm	10

Lama sega universale
per metallo

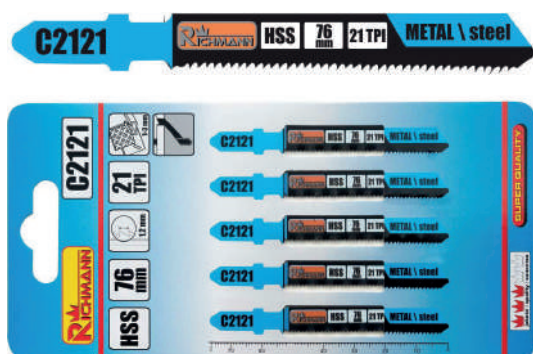

NEW

21 TPI HM TCT

CODICE	DESCRIZIONE	Q.TÀ
C2121	LUNGHEZZA 76 mm	10

Lama sega universale
per metallo taglio curvo

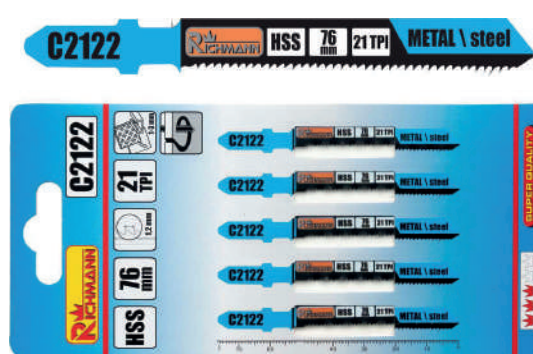

NEW

21 TPI HM TCT

CODICE	DESCRIZIONE	Q.TÀ
C2122	LUNGHEZZA 76 mm	10

Lama sega universale
per legno

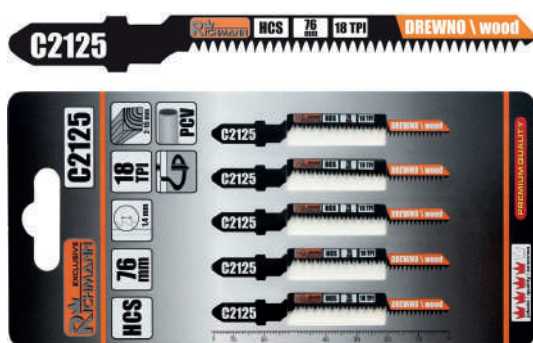

NEW

SPESORE 2-15 mm 18 TPI HCS

CODICE	DESCRIZIONE	Q.TÀ
C2125	LUNGHEZZA 76 mm	10

Lama sega universale
per legno

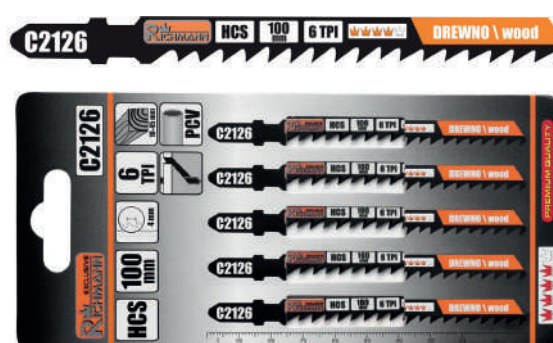

NEW

SPESORE 10-45 mm 6 TPI HCS

CODICE	DESCRIZIONE	Q.TÀ
C2126	LUNGHEZZA 100 mm	10

Lama sega universale
per legno



NEW

SPESORE 4-50 mm 8 TPI HCS

CODICE	DESCRIZIONE	Q.TÀ
C2128	LUNGHEZZA 100 mm	10

Lama sega universale
per legno



NEW

SPESORE 3-30 mm 10 TPI HCS

CODICE	DESCRIZIONE	Q.TÀ
C2129	LUNGHEZZA 100 mm	10

Set lame per seghetto

con 10 lame

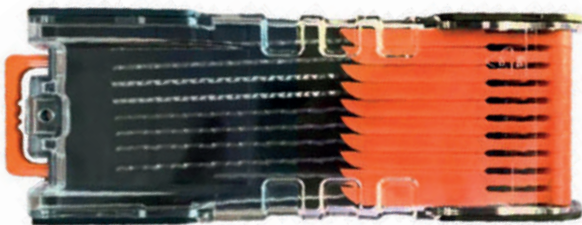

NEW

CODICE	DESCRIZIONE	Q.TÀ
C2137	C2121	METALLO
	C2122	METALLO
	C2125	LEGNO
	C2126	LEGNO
	C2127	LEGNO
	C2128	METALLO
	C2129	LEGNO

Lama sega universale

per legno

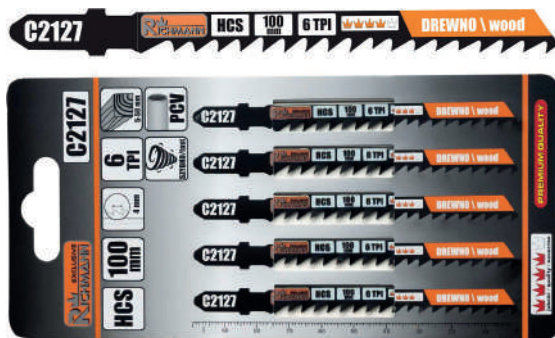

NEW

SPESSORE 5-50 mm	6 TPI	HCS
---------------------	----------	-----

CODICE	DESCRIZIONE	Q.TÀ
C2127	LUNGHEZZA 100 mm	10
C2131	LUNGHEZZA 152 mm	10

Lama sega universale

per legno con denti rovesci

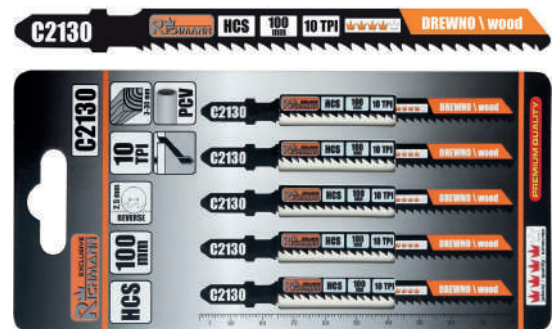

NEW

SPESSORE 3-30 mm	10 TPI	HCS
---------------------	-----------	-----

CODICE	DESCRIZIONE	Q.TÀ
C2130	LUNGHEZZA 100 mm	10

Lama sega universale per legno

taglio super pulito

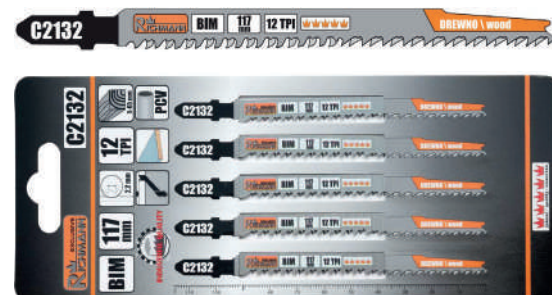

NEW

SPESSORE 5-65 mm	6 TPI	HCS
---------------------	----------	-----

CODICE	DESCRIZIONE	Q.TÀ
C2132	LUNGHEZZA 117 mm	10

Archetto manuale

con lama intercambiabile



515 mm

CODICE	DESCRIZIONE	Q.TÀ
C1900	PER FERRO LAMA 300 mm	6

Seghetto manuale

con doppia lama



350 mm

CODICE	DESCRIZIONE	Q.TÀ
C1902	PER LEGNO, PLASTICA, METALLO E ALLUMINIO LAMA 300 mm	6

Archetto manuale professionale

con lama intercambiabile



455 mm

CODICE	DESCRIZIONE	Q.TÀ
C1903	PER FERRO LAMA 300 mm	6

Sega professionale

per legno con impugnatura in teflon



LEGNO ACCIAIO MN65 7 POLLICI

CODICE	DESCRIZIONE	Q.TÀ
C1916	LUNGHEZZA LAMA 400 mm	10
C1918	LUNGHEZZA LAMA 450 mm	10

Sega per legno

con impugnatura in TEFLON



LEGNO ACCIAIO MN65 7/12 POLLICI

CODICE	DESCRIZIONE	Q.TÀ
C1915	LUNGHEZZA LAMA 400 mm	10

Sega tagliacornici

per legno con impugnatura in teflon



LEGNO ACCIAIO MN65 11 POLLICI

CODICE	DESCRIZIONE	Q.TÀ
C3910	LUNGHEZZA LAMA 300 mm	10

Sega per legno manuale

con custodia



DUREZZA HRC 50-54 LEGNO ACCIAIO MN65 7 DENTI/POLLICE

CODICE	DESCRIZIONE	Q.TÀ
C1906	LUNGHEZZA LAMA 400 mm	10

Sega per calcestruzzo cellulare
impugnatura in teflon



CALCESTRUZZO

ACCIAIO MN65

CODICE	DESCRIZIONE	Q.TÀ
C1905	LUNGHEZZA LAMA 650 mm	6

Sega per calcestruzzo 17/34 denti
impugnatura in teflon



CALCESTRUZZO

ACCIAIO MN65

CODICE	DESCRIZIONE	Q.TÀ
C1909	SEGACCIO 34/34 DENTI E LAMA 700 mm	6
C1910	SEGACCIO 17/34 DENTI E LAMA 700 mm	6

Segaccio pieghevole
per legno con impugnatura in teflon



LEGNO

ACCIAIO MN65

7 POLLICI

CODICE	DESCRIZIONE	Q.TÀ
C1913	LUNGHEZZA LAMA 180 mm	6

Segaccio con fodero
per legno con impugnatura in teflon



LEGNO

ACCIAIO MN65

7 POLLICI

CODICE	DESCRIZIONE	Q.TÀ
C1911	LUNGHEZZA LAMA 350 mm	6

Segaccio con foro per manico
impugnatura in teflon



LEGNO

ACCIAIO MN65

7 POLLICI

CODICE	DESCRIZIONE	Q.TÀ
C1917	LUNGHEZZA LAMA 350 mm	6

Seghetto Bremak
per legno/pvc



LEGNO E PVC

CODICE	DESCRIZIONE	Q.TÀ
108265/LEGNO	SEGHETTO LEGNO/PVC SPECIALE A TIRARE	12

Segaccio per cartongesso PREMIUM QUALITY

impugnatura in teflon



ACCIAIO MN65

7 POLLICI

CODICE	DESCRIZIONE	Q.TÀ
C1901	LUNGHEZZA LAMA 150 mm	20

FLESSOMETRO 28MM DOUBLE

25mm x 3/5/8m

Pag. 44



Introduciamo il nuovo flessometro Bremak, caratterizzato da una cassa rossa in materiale ABS, di forma ergonomica e dotata di clip per un'affidabilità incomparabile. L'innovativo bloccaggio e rientro automatico permettono di gestire più facilmente l'operazione del nastro. Il nastro doppio giallo, smaltato e opaco, di tipo antiriflesso, garantisce una scissione veloce e soddisfacente.

Inoltre, il calciolo è caratterizzato da una superficie zigrinata, ideale per prevenire lo scivolare delle mani. Infine, la battuta ammortizzata durante l'intrusione del calciolo assicura un'ottima manovrabilità maggiormente facilitata. Realizzato in materiale ABS, è caratterizzato da un'elevata durata, è resistente a danni meccanici, graffi, crepe o urti.

Flessometro 28 mm
5mt/8mt double



NEW

28 mm

CODICE	DESCRIZIONE	Q.TÀ
BK6803	FLESSOMETRO 28 mm/3MT DOUBLE	20
BK6805	FLESSOMETRO 28 mm/5MT DOUBLE	20
BK6808	FLESSOMETRO 28 mm/8MT DOUBLE	20
BK6810	FLESSOMETRO 30 mm/10MT	20

Flessometri Bremak
16-25 mm



CODICE	DESCRIZIONE	Q.TÀ
10398363	16 mmx3 MT	12
10398365	19 mmx5 MT	12
10398496	25 mmx5 MT	12
10398497	25 mmx8 MT	12

Sagoma
per profili in metallo

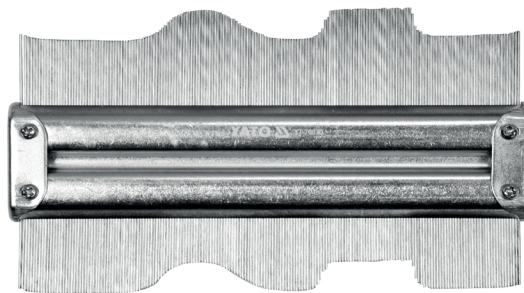

CODICE	DESCRIZIONE	Q.TÀ
YT-70870	LUNGHEZZA 150 mm	10

Squadra PREMIUM QUALITY
in acciaio con brevetto base

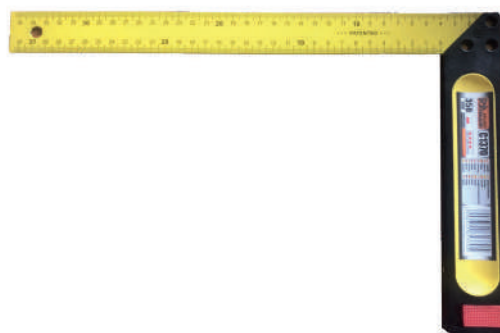

CODICE	DESCRIZIONE	Q.TÀ
C1370	SQUADRA IN ACCIAIO BREVETTATA	10
C1371	SQUADRA IN ACCIAIO BREVETTATA	10
C1372	SQUADRA IN ACCIAIO BREVETTATA	10

Coltello
per legno e polistirene



CODICE	DESCRIZIONE	Q.TÀ
C9140	LUNGHEZZA LAMA 300 mm	10

Flessometro Bremak
doppia graduazione



CODICE	DESCRIZIONE	Q.TÀ
10398761	16 mmx3MT	12
10398764	19x5MT	12

Flessometro
con finestrella per misure interne



CODICE	DESCRIZIONE	Q.TÀ
103164316BVC	3 mmx16MT	12

Rotella metrica
professional quality



100% BEST QUALITY

4:1

ACCIAIO

Flessometro calamitato
con autostop



NEW

CODICE	DESCRIZIONE	Q.TÀ
C1023	FLESSOMETRO CALAMITATO 25 mmx3M	12
C1026	FLESSOMETRO CALAMITATO 25 mmx5M	12
C0128	FLESSOMETRO CALAMITATO 25 mmx8M	12

Forbice inox titan
210/240 mm



210 mm

240 mm

CODICE	DESCRIZIONE	Q.TÀ
BK6801	FORBICE INOX TITAN 210 mm	12
BK6802	FORBICE INOX TITAN 240 mm	12

Rotella metrica
professional quality



100% BEST QUALITY

4:1

FIBRA DI VETRO

CODICE	DESCRIZIONE	Q.TÀ
C1355	20m	12
C1356	30m	12
C1357	50m	12

Sagoma per profili
125 mm



CODICE	DESCRIZIONE	Q.TÀ
YT-3735	LUNGHEZZA 125 mm	10

Sagoma per profili
260 mm



CODICE	DESCRIZIONE	Q.TÀ
YT-3736	LUNGHEZZA 260 mm	10

Calibro ventesimale analogico
in acciaio inossidabile INOX

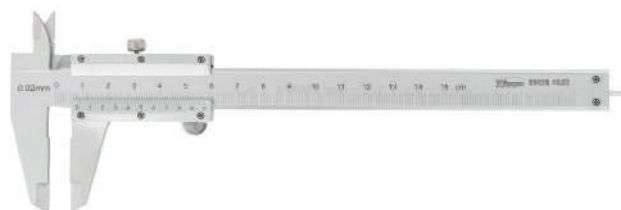
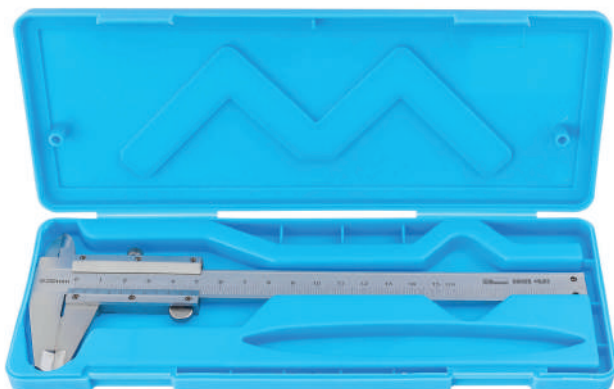

0-150 mm

CODICE	DESCRIZIONE	Q.TÀ
C3425	LUNGHEZZA 150 mm	10

Calibro a corsoio digitale
in acciaio inossidabile INOX



LCD 0-150 mm

CODICE	DESCRIZIONE	Q.TÀ
C3431	LUNGHEZZA 150 mm	10

Contafiletti spessorimetro
0.25-6 mm



CODICE	DESCRIZIONE	Q.TÀ
C9039	52 LAME	10

Livella alluminio
con 2 file

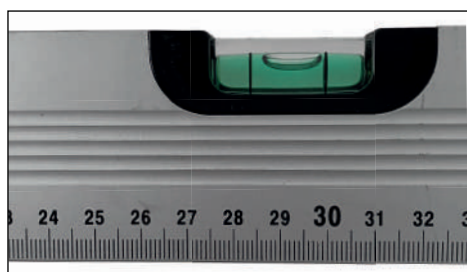

CODICE	DESCRIZIONE	Q.TÀ
10331353	LUNGHEZZA 30 CM	6
10331354	LUNGHEZZA 40 CM	6
10331355	LUNGHEZZA 50 CM	6
10331356	LUNGHEZZA 60 CM	6
10331358	LUNGHEZZA 80 CM	6

Livella in alluminio
magnetica con 3 file

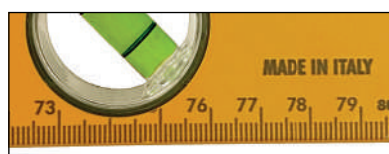
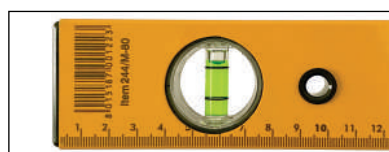

CODICE	DESCRIZIONE	Q.TÀ
103244/M-30	LUNGHEZZA 30 CM	10
103244/M-40	LUNGHEZZA 40 CM	10
103244/M-50	LUNGHEZZA 50 CM	10
103244/M-60	LUNGHEZZA 60 CM	10
103244/M-100	LUNGHEZZA 100 CM	10
103244/M-120	LUNGHEZZA 120 CM	10
103244/M-150	LUNGHEZZA 150 CM	10
103244/M-180	LUNGHEZZA 180 CM	10
103244/M-200	LUNGHEZZA 200 CM	10



LAMPADE

Torcia magnetica

pieghevole, girevole e ricaricabile



27CM

NEW

CODICE	DESCRIZIONE		Q.TÀ		
C6823	2W + 1W MAGNETICO		24		
	BATTERIA	3,7V		800 MAH	
		RICARICABILE (1,5 ORE) USB 240V/5V			
		DURATA		1,5 ORE (100% 2W COB LED)	24
				3 ORE (50% 2W COB LED)	
4 ORE (100% 1W LED)					
INTENSITÀ LUMINOSA	200 LUMEN				

Torcia magnetica

pieghevole, girevole e ricaricabile con luce uv



31CM

NEW

CODICE	DESCRIZIONE		Q.TÀ		
C6824	5W + 1 LED COB LED MAGNETICO CON LUCE UV		24		
	BATTERIA	3,7V		2200 MAH	
		RICARICABILE (3 ORE) USB 240V/5V			
		DURATA		1,5 ORE (100% 5W COB LED)	24
				3 ORE (50% 5W COB LED)	
11 ORE (100% 1W LED)					
INTENSITÀ LUMINOSA	600 LUMEN				

Torcia magnetica ricaricabile

Ricarica batteria 2000mah



24CM

100% BEST QUALITY

CODICE	DESCRIZIONE		Q.TÀ		
C6817	10 SMD-LED+ 6 LED 360° RICARICABILE CON MAGNETI		24		
	BATTERIA	3,7V		2000 MAH	
		RICARICA (4 ORE) USB 230V/5V			
		DURATA		20 ORE (6 LED)	24
				4 ORE (310 COB LED)	
INTENSITÀ LUMINOSA	280 + 30 LUMEN				

Lampada da lavoro

ricaricabile con potenza regolabile



100% BEST QUALITY



CODICE	DESCRIZIONE		Q.TÀ	
C6809	LAMPADA DA LAVORO RICARICABILE		24	
	BATTERIA	3,7V		2600 MAH
		RICARICA USB		
		DURATA CIRCA DUE ORE		
INTENSITÀ LUMINOSA	400 LUMEN			

Torcia magnetica

ricaricabile



CODICE	DESCRIZIONE		Q.TÀ	
C6813	MAGNETICA COB LED 5W + 5 LED ED EMERGENZA		24	
	BATTERIA	3,7V		2000 MAH
		RICARICA (4 ORE) USB 230V/12V		
	DURATA	22 ORE (5 LED)		
		4 ORE (300 COB LED)		
INTENSITÀ LUMINOSA	475 LUMEN			

Torcia ricaricabile

30 Smd led



CODICE	DESCRIZIONE		Q.TÀ	
C6818	TORCIA RICARICABILE 30 SMD LED		10	
	BATTERIA	7,4V		2000 MAH
		RICARICA (4,5 ORE) USB 230V/12V		
		DURATA		2 ORE (LUCE AL 100%)
	4 ORE (LUCE AL 40%)			
INTENSITÀ LUMINOSA	600 LUMEN			

Mini torcia magnetica

Cob-led + 1 led



18CM



CODICE	DESCRIZIONE		Q.TÀ
C6811	MINI TORCIA MAGNETICA COB LED + 1 LED		20
	BATTERIE	X3 AA	
	INTENSITÀ LUMINOSA	145 LUMEN	

Torcia da officina multifunzionale

2x3w cob-led+1



33CM



CODICE	DESCRIZIONE		Q.TÀ	
C6825	BATTERIA	3,7V	2000 MAH	12
		RICARICA (4 ORE) USB 230V/12V		
	DURATA	4 ORE (100% 3W COB LED)		
		2 ORE (100% 6W COB LED)		
		11 ORE (100% 1W LED)		
INTENSITÀ LUMINOSA	2x250 + 30 LUMEN			

Torcia magnetica

ricaricabile e pieghevole



180 mm



CODICE	DESCRIZIONE		Q.TÀ	
C6812	RICARICABILE E MAGNETICA COB LED 1,5W / 1W LED		12	
	BATTERIA	3,7V		800 MAH
		RICARICA USB 5V		
	DURATA	4 ORE (100% 1,5W COB LED)		
		2 ORE (100% 1W LED)		
INTENSITÀ LUMINOSA	145 / 60 LUMEN			

Lampada testa regolabile

Led 3w professionale



CODICE	DESCRIZIONE		Q.TÀ
C5902	LAMPADA DA TESTA REGOLABILE LED 3W		10
	BATTERIE	X3 AA	
	INTENSITÀ LUMINOSA	160 LUMEN	

Lampada da testa e braccio



CODICE	DESCRIZIONE		Q.TÀ
C5900	LAMPADA DA TESTA E BRACCIO LED 1W LED CREE		10
	BATTERIE	X3 AA	
	INTENSITÀ LUMINOSA	60 LUMEN	

Lampada 10 smd

Con cavo da 7mt



IP54

CODICE	DESCRIZIONE		Q.TÀ
C5951	10 SMD LED CON CAVO LUNGO 7MT		10
	CORRENTE	220V- 240V	
	INTENSITÀ LUMINOSA	250 LUMEN	

Lampada da testa e braccio

con accensione automatica



CODICE	DESCRIZIONE		Q.TÀ
C5905	LAMPADA DA TESTA E BRACCIO LED 4W + 2W SMD LED CREE		10
	BATTERIA	3.7V 1000mAh	
		RICARICA 230V/5V USB	
	INTENSITÀ LUMINOSA	300 LUMEN	

Torcia magnetica

5w cob-led +3 Led ricaricabili



CODICE	DESCRIZIONE		Q.TÀ
C6815	TORCIA MAGNETICA 5W COB-LED + 3 LED RICARICABILI		12
	BATTERIA	3.7V 2000mAh	
		RICARICA 230V/5V USB	
	INTENSITÀ LUMINOSA	400+180 LM	

Faro cob-led da 30w ricaricabile



CODICE	DESCRIZIONE		Q.TÀ
C5943	FARO COB LED DA 30W RICARICABILE IP54		6
	BATTERIA	7,4V 6600 MAH	
		RICARICA (5 ORE) USB 230V/12V	
		DURATA	
	INTENSITÀ LUMINOSA	2800 LUMEN	

Lampada regolabile a batteria

con docking station 10w



CODICE	DESCRIZIONE		Q.TÀ
C6819	LAMPADA A BATTERIA CON DOCKING STATION 10W		12
	BATTERIA	3.7V 2000mAh	
		RICARICA 230V/5V USB	
	INTENSITÀ LUMINOSA	DA 250 A 550LM	

Faro cob-led



100% BEST QUALITY



CODICE	DESCRIZIONE		Q.TÀ
C5942	FARO COB LED DA 30W CAVO DA 1,8MT IP54		6
	CORRENTE	230V	
	INTENSITÀ LUMINOSA	3000 LUMEN	

Doppio faro cob-led da 30w + 20w



CODICE	DESCRIZIONE		Q.TÀ
C5944	DOPPIO FARO COB LED DA 30W + 20W CAVO DA 1,8MT IP54		6
	CORRENTE	230V	
	INTENSITÀ LUMINOSA	4500 LUMEN	

Faro cob-led

30w + 2 usb + 2 prese schuko



CODICE	DESCRIZIONE		Q.TÀ
C5947	FARO COB-LED 30W + 2 USB + 2 PRESE SCHUKO CAVO 180 CM		6
	CORRENTE	230V	
	INTENSITÀ LUMINOSA	3000 LUMEN	

Faro cob-led

50w + 2 usb + 2 prese schuko

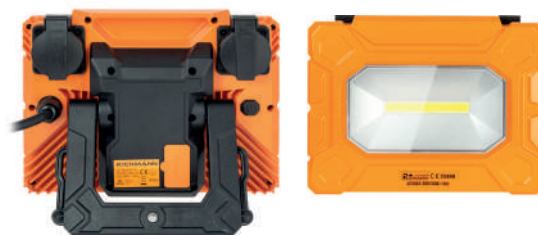

CODICE	DESCRIZIONE		Q.TÀ
C5948	FARO COB-LED 50W+2 USB + 2 PRESE SCHUKO CAVO 180 CM		6
	CORRENTE	230V	
	INTENSITÀ LUMINOSA	5000 LUMEN	

Faro cob-led

20w+cavi auto con morsetti



La capiente batteria da 9600 mha può essere utilizzata come powerbank



CODICE	DESCRIZIONE		Q.TÀ	
C5949	FARO COB LED DA 20W RICARICABILE IP54		6	
	BATTERIA	7,4V		9600 MAH
		RICARICA (5 ORE) USB 230V/15V		
		DURATA		2,2 ORE (LUCE AL 100%) 6,5 ORE (LUCE AL 30%)
	INTENSITÀ LUMINOSA	1800 LUMEN		

Supporto per faro C5940 e C5942

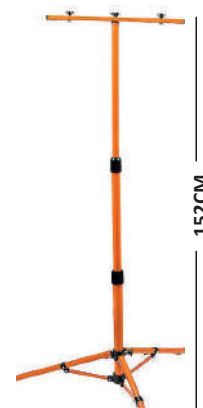

152CM



C5940 C5942

CODICE	DESCRIZIONE	Q.TÀ
C5999	SUPPORTO PER FARO C5940 E C5942	6

Lampada cob-led ricaricabile



CE

CODICE	DESCRIZIONE		Q.TÀ
C5939	LAMPADA COB-LED RICARICABILE		6
	CORRENTE	21W	
	INTENSITÀ LUMINOSA	1500 LUMEN	

Lampada cob-led ricaricabile



CE

CODICE	DESCRIZIONE		Q.TÀ
C5937	LAMPADA COB-LED RICARICABILE		6
	CORRENTE	10W	
	INTENSITÀ LUMINOSA	1150 LUMEN	

Lampada cob-led ricaricabile



100% BEST QUALITY

CE

CODICE	DESCRIZIONE		Q.TÀ
C5938	LAMPADA COB-LED RICARICABILE		6
	CORRENTE	20+3W	
	INTENSITÀ LUMINOSA	2200 LUMEN	

Lampada a led per scarpa luce blu



CE

BLU

CODICE	DESCRIZIONE	Q.TÀ
10714237BL	LAMPADA A LED PER SCARPA LUCE BLU	6

Torcia led telescopica

con specchio



CE

80x50 mm X2 LED

CODICE	DESCRIZIONE	Q.TÀ
C0479	TORCIA LED TELESCOPICA CON SPECCHIO 80x50 mm	12

Torcia rettangolare magnetica e Gancio 24+3led



CE

200 LM X3 AAA

CODICE	DESCRIZIONE	Q.TÀ
C6808	TORCIA CON MAGNETE E GANCIO 24+3LED	12

Supporto magnetico



C5947 C5948 C5949

CODICE	DESCRIZIONE	Q.TÀ
C5946	C5947/C5948/C5949	10

Batteria ricaricabile per lampada



CODICE	DESCRIZIONE	Q.TÀ
C6792	C6812	1
C6793	C6810	1
C6794	C5943	1
C6796	C6820	1
C6797	C6813	1
C6798	C6817	1
C6779	C5905	1

Carica batterie per lampada



CODICE	DESCRIZIONE	Q.TÀ
C6787	C5943	1
C6788	C6813/6817	1
C6789	C6818	1
C6790	C6820	1

Carica batterie usb per lampada



CODICE	DESCRIZIONE	Q.TÀ
C6791	C6812/6813/6817	1

Fascia per testa con luce led



CODICE	DESCRIZIONE	Q.TÀ
BK2020	FASCIA PER LA TESTA NERA CON LED	12
BK2021	FASCIA PER LA TESTA VERDE CON LED	12
BK2022	FASCIA PER LA TESTA ARANCIONE CON LED	12
BK2023	FASCIA PER LA TESTA GIALLA CON LED	12

Berretto invernale led



CODICE	DESCRIZIONE	Q.TÀ
BK2000	BERRETTO NERO CON LED	12
BK2001	BERRETTO MIMETICO CON LED	12
BK2002	BERRETTO ARANCIONE CON LED	12
BK2003	BERRETTO GIALLO CON LED	12



L'azione **NATURALE**
dell'**ARGENTO PURO**
elimina la formazione dei **BATTERI**
e dei **CATTIVI ODORI**

**AZIONE
DUREVOLE
ANCHE DOPO
NUMEROSI LAVAGGI**



BK1001



BK1000



BK1002



BK1003

ANTINFORTUNISTICA

Guanto Hornbill
in nylon con palmo in gomma

CERVA

EN 420



EN 407



EN 388



CODICE	DESCRIZIONE	Q.TÀ
GHORNBILL6	TAGLIA 6	120
GHORNBILL7	TAGLIA 7	120
GHORNBILL8	TAGLIA 8	120
GHORNBILL9	TAGLIA 9	120
GHORNBILL10	TAGLIA 10	120
GHORNBILL11	TAGLIA 11	120

Guanto Smew ultrasottili
in nylon con palmo in poliuretano

CERVA

EN 420



EN 388



CODICE	DESCRIZIONE	Q.TÀ
GSMEW8	TAGLIA 8	120
GSMEW9	TAGLIA 9	120
GSMEW10	TAGLIA 10	120
GSMEW11	TAGLIA 11	120

Guanto Palawan
in nylon con palmo in lattice

CERVA

EN 420



EN 388



CODICE	DESCRIZIONE	Q.TÀ
GPALAWAN7	TAGLIA 7	120
GPALAWAN8	TAGLIA 8	120
GPALAWAN9	TAGLIA 9	120
GPALAWAN10	TAGLIA 10	120
GPALAWAN11	TAGLIA 11	120

Guanto Palawan invernali
in nylon con palmo in lattice

CERVA

EN 420



EN 388
(1121X)



EN 511
(01X)



CODICE	DESCRIZIONE	Q.TÀ
GPALAWANWINTER8	TAGLIA 8	60
GPALAWANWINTER9	TAGLIA 9	60
GPALAWANWINTER10	TAGLIA 10	60
GPALAWANWINTER11	TAGLIA 11	60

Guanto TB700F ZEBRA
in nitrile/PVC

GROUP TB

EN 420



EN 407



EN 388



CODICE	DESCRIZIONE	Q.TÀ
GTB700FZEBRA-8	TAGLIA 8	120
GTB700FZEBRA-9	TAGLIA 9	120
GTB700FZEBRA-10	TAGLIA 10	120
GTB700FZEBRA-11	TAGLIA 11	120

Guanto in tela
per bambino con gancio



CODICE	DESCRIZIONE	Q.TÀ
G.B.P-1	DORSO E MANICHETTA IN TELA 0- 4 ANNI	120
G.B.P-2	DORSO E MANICHETTA IN TELA 4-8 ANNI	120

Guanto Bremak

in nitrile waterproof



EN 420

EN 388



NEW

100% BEST QUALITY

CODICE	DESCRIZIONE	Q.TÀ
BK5000-8	TAGLIA 8	120
BK5000-9	TAGLIA 9	120
BK5000-10	TAGLIA 10	120
BK5000-11	TAGLIA 11	120



Guanto Bunting Evolution

in poliuretano



EN 420

EN 388

(4131X)



CODICE	DESCRIZIONE	Q.TÀ
GBUNTINGEVOLUTION6	TAGLIA 6	120
GBUNTINGEVOLUTION7	TAGLIA 7	120
GBUNTINGEVOLUTION8	TAGLIA 8	120
GBUNTINGEVOLUTION9	TAGLIA 9	120
GBUNTINGEVOLUTION10	TAGLIA 10	120
GBUNTINGEVOLUTION11	TAGLIA 11	120

Guanto Chunky

guanti nylon con palmo in lattice



EN 420

EN 388

(3122X)



CODICE	DESCRIZIONE	Q.TÀ
GCHUNKY4	TAGLIA 4	120
GCHUNKY5	TAGLIA 5	120

Guanto Babbler

guanti nylon con palmo in nitrile



EN 420

EN 388

(4131X)



CODICE	DESCRIZIONE	Q.TÀ
GBABBLER7	TAGLIA 7	120
GBABBLER8	TAGLIA 8	120
GBABBLER9	TAGLIA 9	120
GBABBLER10	TAGLIA 10	120
GBABBLER11	TAGLIA 11	120

Guanto Nigra

antivibrazione



EN 420

CODICE	DESCRIZIONE	Q.TÀ
GNIGRA10	TAGLIA 10	60



Guanto Atthis
antivibrazione



EN ISO 10819

EN 420



EN 388
(4142X)

CODICE	DESCRIZIONE	Q.TÀ
GATTHIS10	TAGLIA 10	60

Guanto Nyroca



EN 420

EN 407



EN 388



CODICE	DESCRIZIONE	Q.TÀ
G5217316	TAGLIA 6	120
G5217317	TAGLIA 7	120
G5217318	TAGLIA 8	120
G5217319	TAGLIA 9	120
G52173110	TAGLIA 10	120

Guanto Summit
top pelle



EN 388
(2122)

CODICE	DESCRIZIONE	Q.TÀ
GPF-8-M	TAGLIA 8	120
GPF-9-L	TAGLIA 9	120
GPF-10-XL	TAGLIA 10	120
GPF-11-XXL	TAGLIA 11	120

Guanto Sandpiper
saldatore



EN 407
(413X3X)



EN 388
(2144)

CODICE	DESCRIZIONE	Q.TÀ
GSANDPIPERRED11	TAGLIA 11	60
GSANDPIPERRED12	TAGLIA 12	60

Guanto CS-CUT F13

antitaglio in nitrile



CODICE	DESCRIZIONE	Q.TÀ
4A672K8R08	TAGLIA 8	120
4A672K8R09	TAGLIA 9	120
4A672K8R10	TAGLIA 10	120
4A672K8R11	TAGLIA 11	120

Guanto Impact

antitaglio



CODICE	DESCRIZIONE	Q.TÀ
GTB490RMFIMPACT-8	TAGLIA 8	120
GTB490RMFIMPACT-9	TAGLIA 9	120
GTB490RMFIMPACT-10	TAGLIA 10	120
GTB490RMFIMPACT-11	TAGLIA 11	120

Guanto HS-04-017

antitaglio



CODICE	DESCRIZIONE	Q.TÀ
GHS-04-017-7	TAGLIA 7	120
GHS-04-017-8	TAGLIA 8	120
GHS-04-017-9	TAGLIA 9	120
GHS-04-017-10	TAGLIA 10	120
GHS-04-017-11	TAGLIA 11	120

Guanto HS-04-018

antitaglio



CODICE	DESCRIZIONE	Q.TÀ
GHS-04-018-7	TAGLIA 7	120
GHS-04-018-8	TAGLIA 8	120
GHS-04-018-9	TAGLIA 9	120
GHS-04-018-10	TAGLIA 10	120
GHS-04-018-11	TAGLIA 11	120

Guanto pelican in pelle di pecora

con maglia in cotone



CODICE	DESCRIZIONE	Q.TÀ
CPP005-S	TAGLIA S	120
CPP005-M	TAGLIA M	120
CPP005-L	TAGLIA L	120
CPP005-XL	TAGLIA XL	120

Una vasta gamma di applicazioni: laboratori, stabilimenti farmaceutici, ospedali e sanità. Quando si lavora con citostatici, industria alimentare, salute e sicurezza sul lavoro, parrucchieri e cosmetologia, studi di tatuaggi, meccanici di veicoli e piccoli lavori domestici.

Guanto Corona

in pelle di capra



CODICE	DESCRIZIONE	Q.TÀ
G-C8509	TAGLIA 9	120
G-C8510	TAGLIA 10	120

Guanto Caspia

in lattice/neoprene antiacido



EN 420



EN ISO 374-1
(tipo A2 K6 L3 M5 N2
O1 P6 S6 T6)

CODICE	DESCRIZIONE	Q.TÀ
GCASPIA7	TAGLIA 7	72
GCASPIA8	TAGLIA 8	72
GCASPIA9	TAGLIA 9	72
GCASPIA10	TAGLIA 10	72

Berretto Tahr baseball



NEW

60 % cotone, 40 % poliestere

CODICE	DESCRIZIONE	Q.TÀ
4TAHRG	GIALLO	120
4TAHRA	ARANCIONE	120

Cappello Neurum camouflage



100 % cotone

CODICE	DESCRIZIONE	Q.TÀ
4NEURUM	MIMETICO	120

Cappello ricamabile Meest



NEW

100 % acrilico

CODICE	DESCRIZIONE	Q.TÀ
4MEESTBIANCO	CAPPELLO MEEST BIANCO	24
4MEESTNERO	CAPPELLO MEEST NERO	24
4MEESTGIALLO	CAPPELLO MEEST GIALLO	24
4MEESTARANCIO	CAPPELLO MEEST ARANCIO	24
4MEESTBLU	CAPPELLO MEEST BLU	24
4MEESTGRIGIO	CAPPELLO MEEST GRIGIO	24

Berretto Turia



NEW

100 % poliestere

CODICE	DESCRIZIONE	Q.TÀ
4TURIAG	GIALLO	120
4TURIA	ARANCIONE	120

Calzini Bremak estivi



L'azione **NATURALE** dell'**ARGENTO PURO** elimina la formazione dei **BATTERI** e dei **CATTIVI ODORI**



AZIONE DUREVOLE ANCHE DOPO NUMEROSI LAVAGGI

84% dryarn, 10% poliammide, 5% elasthan, fibra d'argento

CODICE	DESCRIZIONE	Q.TÀ
BK1001-35/38	3 PAIA TAGLIA 35/38	24
BK1001-39/42	3 PAIA TAGLIA 39/42	24
BK1001-43/46	3 PAIA TAGLIA 43/46	24

Calzini Bremak estivi Bike



L'azione **NATURALE** dell'**ARGENTO PURO** elimina la formazione dei **BATTERI** e dei **CATTIVI ODORI**



AZIONE DUREVOLE ANCHE DOPO NUMEROSI LAVAGGI

46% dryarn, 47% poliammide, 5% elasthan, fibra d'argento

CODICE	DESCRIZIONE	Q.TÀ
BK1000-35/38	2 PAIA TAGLIA 35/38	24
BK1000-39/42	2 PAIA TAGLIA 39/42	24
BK1000-43/46	2 PAIA TAGLIA 43/46	24

Calze 4 stagioni

Fibra argentata, dryarn, circolazione



L'azione **NATURALE** dell'**ARGENTO PURO** elimina la formazione dei **BATTERI** e dei **CATTIVI ODORI**



AZIONE DUREVOLE ANCHE DOPO NUMEROSI LAVAGGI

43% dryarn, 20% poliammide, 30% prolen, 5% elasthan, fibra d'argento

CODICE	DESCRIZIONE	Q.TÀ
BK1002-35/38	1 PAIO TAGLIA 35/38	12
BK1002-39/42	1 PAIO TAGLIA 39/42	12
BK1002-43/46	1 PAIO TAGLIA 43/46	12

Calze lunghe invernali Dryarn



40% dryarn, 23% poliammide, 5% elasthan

CODICE	DESCRIZIONE	Q.TÀ
BK1003-35/38	1 PAIO TAGLIA 35/38	12
BK1003-39/42	1 PAIO TAGLIA 39/42	12
BK1003-43/46	1 PAIO TAGLIA 43/46	12

Giacca Neurum invernale



Disponibile anche nei colori illustrati

EN ISO 13688**Strato superiore dell'abbigliamento:**

100% poliestere, 150 g/m², elasticità meccanica

Fodera interna dell'abito:

100% poliestere

Isolamento interno degli indumenti:

100% poliestere

Caratteristiche:

impermeabile, traspirante, antivento

Permeabilità al vapore:

3000 g/m²/24h

Componenti:

- Cappuccio imbottito staccabile e parte posteriore prolungata
- Ventilazione sotto le ascelle
- 2 tasche laterali con cerniera
- 1 tasca sul petto con cerniera
- 1 tasca sulla manica con cerniera
- 2 tasche interne con cerniera
- 2 tasche multifunzione
- Coulisse nella parte inferiore e cappuccio
- Fondo manica regolabile tramite velcro.

Taglie:

CODICE	DESCRIZIONE	Q.TÀ
4NEURUMPARKAA-S	GIACCA PESANTE ANTRACITE S	1
4NEURUMPARKAA-M	GIACCA PESANTE ANTRACITE M	1
4NEURUMPARKAA-L	GIACCA PESANTE ANTRACITE L	1
4NEURUMPARKAA-XL	GIACCA PESANTE ANTRACITE XL	1
4NEURUMPARKAA-2XL	GIACCA PESANTE ANTRACITE 2XL	1
4NEURUMPARKAA-3XL	GIACCA PESANTE ANTRACITE 3XL	1
4NEURUMPARKAA-4XL	GIACCA PESANTE ANTRACITE 4XL	1
4NEURUMPARKAB-S	GIACCA PESANTE BLU S	1
4NEURUMPARKAB-M	GIACCA PESANTE BLU M	1
4NEURUMPARKAB-L	GIACCA PESANTE BLU L	1
4NEURUMPARKAB-XL	GIACCA PESANTE BLU XL	1
4NEURUMPARKAB-2XL	GIACCA PESANTE BLU 2XL	1
4NEURUMPARKAB-3XL	GIACCA PESANTE BLU 3XL	1
4NEURUMPARKAB-4XL	GIACCA PESANTE BLU 4XL	1
4NEURUMPARKAPB-S	GIACCA PESANTE BLU PETROLIO S	1
4NEURUMPARKAPB-M	GIACCA PESANTE BLUPETROLIO M	1
4NEURUMPARKAPB-L	GIACCA PESANTE BLU PETROLIO L	1
4NEURUMPARKAPB-XL	GIACCA PESANTE BLU PETROLIO XL	1
4NEURUMPARKAPB-2XL	GIACCA PESANTE BLU PETROLIO 2XL	1
4NEURUMPARKAPB-3XL	GIACCA PESANTE BLU PETROLIO 3XL	1
4NEURUMPARKAPB-4XL	GIACCA PESANTE BLU PETROLIO 4XL	1
4NEURUMPARKAVO-S	GIACCA PESANTE VERDE OLIVA S	1
4NEURUMPARKAVO-M	GIACCA PESANTE VERDE OLIVA M	1
4NEURUMPARKAVO-L	GIACCA PESANTE VERDE OLIVA L	1
4NEURUMPARKAVO-XL	GIACCA PESANTE VERDE OLIVA XL	1
4NEURUMPARKAVO-2XL	GIACCA PESANTE VERDE OLIVA 2XL	1
4NEURUMPARKAVO-3XL	GIACCA PESANTE VERDE OLIVA 3XL	1
4NEURUMPARKAVO-4XL	GIACCA PESANTE VERDE OLIVA 4XL	1

Giacca Neurum softshell leggera



Disponibile anche nei colori illustrati

EN ISO 13688**Strato superiore dell'abbigliamento:**

100% poliestere, 280 g/m², elasticità meccanica

Fodera interna dell'abito:

100% poliestere

Isolamento interno degli indumenti:

100% poliestere

Componenti:

- colletto rialzato
- 2 tasche laterali con cerniera
- 1 tasca sul petto con cerniera
- dettagli riflettenti tono su tono
- bordini elastici su maniche e orli inferiori
- fori per i pollici sulle maniche

Taglie:

CODICE	DESCRIZIONE	Q.TÀ
4NEURUMSOFTSHEBP-S	GIACCA SOFTSHELL BLU PETROLIO S	1
4NEURUMSOFTSHEBP-M	GIACCA SOFTSHELL BLU PETROLIO M	1
4NEURUMSOFTSHEBP-L	GIACCA SOFTSHELL BLU PETROLIO L	1
4NEURUMSOFTSHEBP-XL	GIACCA SOFTSHELL BLU PETROLIO XL	1
4NEURUMSOFTSHEBP-2XL	GIACCA SOFTSHELL BLU PETROLIO 2XL	1
4NEURUMSOFTSHEBP-3XL	GIACCA SOFTSHELL BLU PETROLIO 3XL	1
4NEURUMSOFTSHEBP-4XL	GIACCA SOFTSHELL BLU PETROLIO 4XL	1
4NEURUMSOFTSHELA-S	GIACCA SOFTSHELL ANRACITE S	1
4NEURUMSOFTSHELA-M	GIACCA SOFTSHELL ANRACITE M	1
4NEURUMSOFTSHELA-L	GIACCA SOFTSHELL ANRACITE L	1
4NEURUMSOFTSHELA-XL	GIACCA SOFTSHELL ANRACITE XL	1
4NEURUMSOFTSHELA-2XL	GIACCA SOFTSHELL ANRACITE 2XL	1
4NEURUMSOFTSHELA-3XL	GIACCA SOFTSHELL ANRACITE 3XL	1
4NEURUMSOFTSHELA-4XL	GIACCA SOFTSHELL ANRACITE 4XL	1
4NEURUMSOFTSHELB-S	GIACCA SOFTSHELL BLU S	1
4NEURUMSOFTSHELB-M	GIACCA SOFTSHELL BLU M	1
4NEURUMSOFTSHELB-L	GIACCA SOFTSHELL BLU L	1
4NEURUMSOFTSHELB-XL	GIACCA SOFTSHELL BLU XL	1
4NEURUMSOFTSHELB-2XL	GIACCA SOFTSHELL BLU 2XL	1
4NEURUMSOFTSHELB-3XL	GIACCA SOFTSHELL BLU 3XL	1
4NEURUMSOFTSHELB-4XL	GIACCA SOFTSHELL BLU 4XL	1
4NEURUMSOFTSHEVO-S	GIACCA SOFTSHELL VERDE OLIVA S	1
4NEURUMSOFTSHEVO-M	GIACCA SOFTSHELL VERDE OLIVA M	1
4NEURUMSOFTSHEVO-L	GIACCA SOFTSHELL VERDE OLIVA L	1
4NEURUMSOFTSHEVO-XL	GIACCA SOFTSHELL VERDE OLIVA XL	1
4NEURUMSOFTSHEVO-2XL	GIACCA SOFTSHELL VERDE OLIVA 2XL	1
4NEURUMSOFTSHEVO-3XL	GIACCA SOFTSHELL VERDE OLIVA 3XL	1
4NEURUMSOFTSHEVO-4XL	GIACCA SOFTSHELL VERDE OLIVA 4XL	1



Zaino Neurum camouflage

CERVA

Strato superiore:
100% poliestere

Rinforzo superiore:
100% poliestere

Disponibile anche nei colori illustrati

CODICE	DESCRIZIONE	Q.TÀ
4NEURUMZAINOAN	ZAINO PROFESSIONALE ANTRACITE	15
4NEURUMZAINONA	ZAINO PROFESSIONALE NAVY	15
4NEURUMZAINOPE	ZAINO PROFESSIONALE PETROLIO BLUE	15
4NEURUMZAINOVE	ZAINO PROFESSIONALE VERDE MILITARE	15

Marsupio Neurum camouflaged



100% poliestere

Disponibile anche nei colori illustrati

CODICE	DESCRIZIONE	Q.TÀ
4NEURU mmARSAN	MARSUPIO PROFESSIONALE ANTRACITE	12
4NEURU mmARSNA	MARSUPIO PROFESSIONALE NAVY	12
4NEURU mmARSPE	MARSUPIO PROFESSIONALE PETROLIO BLUE	12
4NEURU mmARSVE	MARSUPIO PROFESSIONALE VERDE MILITARE	12

Pantaloni Jogger Neurum CLS



EN ISO 13688

Strato superiore dell'abbigliamento:

62% cotone, 35% poliestere, 3% spandex, 260 g/m², TRIFIBETEX

Rinforzo superiore degli indumenti:

95% poliammide (nylon), 5% spandex, 230 g/m², CORDURA®

Disponibile anche nei colori illustrati

CODICE	DESCRIZIONE	Q.TÀ
4NEURUMPACLSA-S	PANT JOGGER TRIFIBETEX-PRO ANTRACITE S	1
4NEURUMPACLSA-M	PANT JOGGER TRIFIBETEX-PRO ANTRACITE M	1
4NEURUMPACLSA-L	PANT JOGGER TRIFIBETEX-PRO ANTRACITE L	1
4NEURUMPACLSA-XL	PANT JOGGER TRIFIBETEX-PRO ANTRACITE XL	1
4NEURUMPACLSA-2XL	PANT JOGGER TRIFIBETEX-PRO ANTRACITE 2XL	1
4NEURUMPACLSA-3XL	PANT JOGGER TRIFIBETEX-PRO ANTRACITE 3XL	1
4NEURUMPACLSB-S	PANT JOGGER TRIFIBETEX-PRO BLU S	1
4NEURUMPACLSB-M	PANT JOGGER TRIFIBETEX-PRO BLU M	1
4NEURUMPACLSB-L	PANT JOGGER TRIFIBETEX-PRO BLU L	1
4NEURUMPACLSB-XL	PANT JOGGER TRIFIBETEX-PRO BLU XL	1
4NEURUMPACLSB-2XL	PANT JOGGER TRIFIBETEX-PRO BLU 2XL	1
4NEURUMPACLSB-3XL	PANT JOGGER TRIFIBETEX-PRO BLU 3XL	1
4NEURUMPACLSB-4XL	PANT JOGGER TRIFIBETEX-PRO BLU 4XL	1
4NEURUMPACLSBP-S	P JOGGER TRIFIBE-PRO BLU PETROLIO S	1
4NEURUMPACLSBP-M	P JOGGER TRIFIBE-PRO BLU PETROLIO M	1
4NEURUMPACLSBP-L	P JOGGER TRIFIBE-PRO BLU PETROLIO L	1
4NEURUMPACLSBP-XL	P JOGGER TRIFIBE-PRO BLU PETROLIO XL	1
4NEURUMPACLSBP-2XL	P JOGGER TRIFIBE-PRO BLU PETROLIO 2XL	1
4NEURUMPACLSBP-3XL	P JOGGER TRIFIBE-PRO BLU PETROLIO 3XL	1
4NEURUMPACLSVO-S	P JOGGER TRIFIBE-PRO VERDE OLIVA S	1
4NEURUMPACLSVO-M	P JOGGER TRIFIBE-PRO VERDE OLIVA M	1
4NEURUMPACLSVO-L	P JOGGER TRIFIBE-PRO VERDE OLIVA L	1
4NEURUMPACLSVO-XL	P JOGGER TRIFIBE-PRO VERDE OLIVA XL	1
4NEURUMPACLSVO-2XL	P JOGGER TRIFIBE-PRO VERDE OLIVA 2XL	1
4NEURUMPACLSVO-3XL	P JOGGER TRIFIBE-PRO VERDE OLIVA 3XL	1

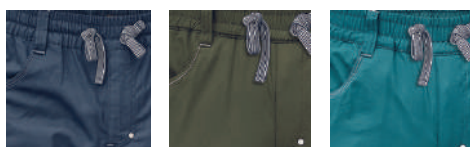

Pantaloni Neurum PFM

CODICE	DESCRIZIONE	Q.TÀ
4NEURUMPAPFMB-46	PANTALONE TRIFIBETEX-PRO BLU 46	1
4NEURUMPAPFMB-48	PANTALONE TRIFIBETEX-PRO BLU 48	1
4NEURUMPAPFMB-50	PANTALONE TRIFIBETEX-PRO BLU 50	1
4NEURUMPAPFMB-52	PANTALONE TRIFIBETEX-PRO BLU 52	1
4NEURUMPAPFMB-54	PANTALONE TRIFIBETEX-PRO BLU 54	1
4NEURUMPAPFMB-56	PANTALONE TRIFIBETEX-PRO BLU 56	1
4NEURUMPAPFMB-58	PANTALONE TRIFIBETEX-PRO BLU 58	1
4NEURUMPAPFMVO-46	PANTALONE TRIFIBETEX-PRO VERDE OLIVA 46	1
4NEURUMPAPFMVO-48	PANTALONE TRIFIBETEX-PRO VERDE OLIVA 48	1
4NEURUMPAPFMVO-50	PANTALONE TRIFIBETEX-PRO VERDE OLIVA 50	1
4NEURUMPAPFMVO-52	PANTALONE TRIFIBETEX-PRO VERDE OLIVA 52	1
4NEURUMPAPFMVO-54	PANTALONE TRIFIBETEX-PRO VERDE OLIVA 54	1
4NEURUMPAPFMVO-56	PANTALONE TRIFIBETEX-PRO VERDE OLIVA 56	1
4NEURUMPAPFMVO-58	PANTALONE TRIFIBETEX-PRO VERDE OLIVA 58	1
4NEURUMPAPFMBP-46	PANTALONE TRIFIBETEX-PRO BLU PETROLIO 46	1
4NEURUMPAPFMBP-48	PANTALONE TRIFIBETEX-PRO BLU PETROLIO 48	1
4NEURUMPAPFMBP-50	PANTALONE TRIFIBETEX-PRO BLU PETROLIO 50	1
4NEURUMPAPFMBP-52	PANTALONE TRIFIBETEX-PRO BLU PETROLIO 52	1
4NEURUMPAPFMBP-54	PANTALONE TRIFIBETEX-PRO BLU PETROLIO 54	1
4NEURUMPAPFMBP-56	PANTALONE TRIFIBETEX-PRO BLU PETROLIO 56	1
4NEURUMPAPFMBP-58	PANTALONE TRIFIBETEX-PRO BLU PETROLIO 58	1
4NEURUMPAPFMA-46	PANTALONE TRIFIBETEX-PRO ANTRACITE 46	1
4NEURUMPAPFMA-48	PANTALONE TRIFIBETEX-PRO ANTRACITE 48	1
4NEURUMPAPFMA-50	PANTALONE TRIFIBETEX-PRO ANTRACITE 50	1
4NEURUMPAPFMA-52	PANTALONE TRIFIBETEX-PRO ANTRACITE 52	1
4NEURUMPAPFMA-54	PANTALONE TRIFIBETEX-PRO ANTRACITE 54	1
4NEURUMPAPFMA-56	PANTALONE TRIFIBETEX-PRO ANTRACITE 56	1
4NEURUMPAPFMA-58	PANTALONE TRIFIBETEX-PRO ANTRACITE 58	1



EN ISO 13688

Strato superiore dell'abbigliamento:
62% cotone, 35% poliestere, 3% spandex, 260 g/m², TRIFIBETEX

Rinforzo superiore degli indumenti:
95% poliammide (nylon), 5% spandex, 230 g/m², CORDURA®

Disponibile anche nei colori illustrati



Tuta categoria III tipo 5-6 cucita

SPECIFICHE	ALTEZZA (CM)	PETTO (CM)	BRACCIA (CM)	POLSO (CM)
M	170-176	92-100	90	18
L	176-182	100-108	93	18
XL	182-188	108-116	94	18
XXL	188-194	116-124	95	18
XXXL	194-200	124-132	97	18

CODICE	DESCRIZIONE	Q.TÀ
TM56-M	TAGLIA M	50
TM56-L	TAGLIA L	50
TM56-XL	TAGLIA XL	50
TM56-XXL	TAGLIA XXL	50



EN ISO 13034:2005+A1:2009,
EN ISO 13982-1:2004+A1:2010,
EN 1149-5:2008



Pantalone uomo nero Dryarn



70% polipropilene , 20% polia mmide, 10% elasthan

CODICE	DESCRIZIONE	Q.TÀ
BKDRYARN/PANT-S/M	TAGLIA S/M	12
BKDRYARN/PANT-L/XL	TAGLIA L/XL	12
BKDRYARN/PANT-XXL	TAGLIA XXL	12

T-shirt uomo nera Dryarn



70% polipropilene, 20% polia mmide, 10% elasthan

CODICE	DESCRIZIONE	Q.TÀ
BKDRYARN/TSHIRT-S/M	TAGLIA S / M	12
BKDRYARN/TSHIRT-L/XL	TAGLIA L / XL	12
BKDRYARN/TSHIRT-XXL	TAGLIA XXL	12

Lupetto uomo nera Dryarn



70% polipropilene , 20% polia mmide, 10% elasthan

CODICE	DESCRIZIONE	Q.TÀ
BKDRYARN/LUPETT-S/M	TAGLIA S/M	12
BKDRYARN/LUPETT-L/XL	TAGLIA L /XL	12
BKDRYARN/LUPETT-XXL	TAGLIA XXL	12

Giacca Allyn

CERVA



EN ISO 13688

65 % poliestere, 35 % cotone, 290 g/m²

CODICE	DESCRIZIONE	Q.TÀ
4ALLYNGIAB/G46	BIANCO/GRIGIO TAGLIA 46	12
4ALLYNGIAB/G48	BIANCO/GRIGIO TAGLIA 48	12
4ALLYNGIAB/G50	BIANCO/GRIGIO TAGLIA 50	12
4ALLYNGIAB/G52	BIANCO/GRIGIO TAGLIA 52	12
4ALLYNGIAB/G54	BIANCO/GRIGIO TAGLIA 54	12
4ALLYNGIAB/G56	BIANCO/GRIGIO TAGLIA 56	12
4ALLYNGIAB/G58	BIANCO/GRIGIO TAGLIA 58	12
4ALLYNGIAB/G60	BIANCO/GRIGIO TAGLIA 60	12
4ALLYNGIAB/G62	BIANCO/GRIGIO TAGLIA 62	12
4ALLYNGIAGRIGIO46	GRIGIO TAGLIA 46	12
4ALLYNGIAGRIGIO48	GRIGIO TAGLIA 48	12
4ALLYNGIAGRIGIO50	GRIGIO TAGLIA 50	12
4ALLYNGIAGRIGIO52	GRIGIO TAGLIA 52	12
4ALLYNGIAGRIGIO54	GRIGIO TAGLIA 54	12
4ALLYNGIAGRIGIO56	GRIGIO TAGLIA 56	12
4ALLYNGIAGRIGIO58	GRIGIO TAGLIA 58	12
4ALLYNGIAGRIGIO60	GRIGIO TAGLIA 60	12
4ALLYNGIAGRIGIO62	GRIGIO TAGLIA 62	12

Pantalone Allyn

CERVA



EN ISO 13688

65 % poliestere, 35 % cotone, 290 g/m²

CODICE	DESCRIZIONE	Q.TÀ
4ALLYNPAB/G46	BIANCO/GRIGIO TAGLIA 46	12
4ALLYNPAB/G48	BIANCO/GRIGIO TAGLIA 48	12
4ALLYNPAB/G50	BIANCO/GRIGIO TAGLIA 50	12
4ALLYNPAB/G52	BIANCO/GRIGIO TAGLIA 52	12
4ALLYNPAB/G54	BIANCO/GRIGIO TAGLIA 54	12
4ALLYNPAB/G56	BIANCO/GRIGIO TAGLIA 56	12
4ALLYNPAB/G58	BIANCO/GRIGIO TAGLIA 58	12
4ALLYNPAB/G60	BIANCO/GRIGIO TAGLIA 60	12
4ALLYNPAB/G62	BIANCO/GRIGIO TAGLIA 62	12
4ALLYNPAGRIGIO46	GRIGIO TAGLIA 46	12
4ALLYNPAGRIGIO48	GRIGIO TAGLIA 48	12
4ALLYNPAGRIGIO50	GRIGIO TAGLIA 50	12
4ALLYNPAGRIGIO52	GRIGIO TAGLIA 52	12
4ALLYNPAGRIGIO54	GRIGIO TAGLIA 54	12
4ALLYNPAGRIGIO56	GRIGIO TAGLIA 56	12
4ALLYNPAGRIGIO58	GRIGIO TAGLIA 58	12
4ALLYNPAGRIGIO60	GRIGIO TAGLIA 60	12
4ALLYNPAGRIGIO62	GRIGIO TAGLIA 62	12

Giacca Montrose

CERVA



EN ISO 13688

60 % cotone, 40 % poliestere, 200 g/m², twill intrecciato

CODICE	DESCRIZIONE	Q.TÀ
4MONTRGIA44	BIANCO/GRIGIO TAGLIA 44	12
4MONTRGIA46	BIANCO/GRIGIO TAGLIA 46	12
4MONTRGIA48	BIANCO/GRIGIO TAGLIA 48	12
4MONTRGIA50	BIANCO/GRIGIO TAGLIA 50	12
4MONTRGIA52	BIANCO/GRIGIO TAGLIA 52	12
4MONTRGIA54	BIANCO/GRIGIO TAGLIA 54	12
4MONTRGIA56	BIANCO/GRIGIO TAGLIA 56	12
4MONTRGIA58	BIANCO/GRIGIO TAGLIA 58	12
4MONTRGIA60	BIANCO/GRIGIO TAGLIA 60	12
4MONTRGIA62	BIANCO/GRIGIO TAGLIA 62	12
4MONTRGIA64	BIANCO/GRIGIO TAGLIA 64	12
4MONTRGIA66	BIANCO/GRIGIO TAGLIA 66	12
4MONTRGIABLU44	BLU/NAVY TAGLIA 44	12
4MONTRGIABLU46	BLU/NAVY TAGLIA 46	12
4MONTRGIABLU48	BLU/NAVY TAGLIA 48	12
4MONTRGIABLU50	BLU/NAVY TAGLIA 50	12
4MONTRGIABLU52	BLU/NAVY TAGLIA 52	12
4MONTRGIABLU54	BLU/NAVY TAGLIA 54	12
4MONTRGIABLU56	BLU/NAVY TAGLIA 56	12
4MONTRGIABLU58	BLU/NAVY TAGLIA 58	12
4MONTRGIABLU60	BLU/NAVY TAGLIA 60	12
4MONTRGIABLU62	BLU/NAVY TAGLIA 62	12
4MONTRGIABLU64	BLU/NAVY TAGLIA 64	12
4MONTRGIABLU66	BLU/NAVY TAGLIA 66	12

Pantalone Montrose

CERVA



EN ISO 13688

60 % cotone, 40 % poliestere, 200 g/m², twill intrecciato

CODICE	DESCRIZIONE	Q.TÀ
4MONTRPA44	BIANCO/GRIGIO TAGLIA 44	12
4MONTRPA46	BIANCO/GRIGIO TAGLIA 46	12
4MONTRPA48	BIANCO/GRIGIO TAGLIA 48	12
4MONTRPA50	BIANCO/GRIGIO TAGLIA 50	12
4MONTRPA52	BIANCO/GRIGIO TAGLIA 52	12
4MONTRPA54	BIANCO/GRIGIO TAGLIA 54	12
4MONTRPA56	BIANCO/GRIGIO TAGLIA 56	12
4MONTRPA58	BIANCO/GRIGIO TAGLIA 58	12
4MONTRPA60	BIANCO/GRIGIO TAGLIA 60	12
4MONTRPA62	BIANCO/GRIGIO TAGLIA 62	12
4MONTRPA64	BIANCO/GRIGIO TAGLIA 64	12
4MONTRPA66	BIANCO/GRIGIO TAGLIA 66	12
4MONTRPABLU44	BLU/NAVY TAGLIA 44	12
4MONTRPABLU46	BLU/NAVY TAGLIA 46	12
4MONTRPABLU48	BLU/NAVY TAGLIA 48	12
4MONTRPABLU50	BLU/NAVY TAGLIA 50	12
4MONTRPABLU52	BLU/NAVY TAGLIA 52	12
4MONTRPABLU54	BLU/NAVY TAGLIA 54	12
4MONTRPABLU56	BLU/NAVY TAGLIA 56	12
4MONTRPABLU58	BLU/NAVY TAGLIA 58	12
4MONTRPABLU60	BLU/NAVY TAGLIA 60	12
4MONTRPABLU62	BLU/NAVY TAGLIA 62	12
4MONTRPABLU64	BLU/NAVY TAGLIA 64	12
4MONTRPABLU66	BLU/NAVY TAGLIA 66	12

T-shirt Teesta

CERVA



100 % cotone, 160 g/m²

Disponibili anche nei colori illustrati

CODICE	DESCRIZIONE	Q.TÀ
4TEESTABXS	BEIGE TAGLIA S	12
4TEESTABS	BEIGE TAGLIA M	12
4TEESTABM	BEIGE TAGLIA L	12
4TEESTABL	BEIGE TAGLIA 3XL	12
4TEESTABXL	BEIGE TAGLIA XL	12
4TEESTABXXL	BEIGE TAGLIA XXL	12
4TEESTAB3XL	BEIGE TAGLIA 3XL	12
4TEESTAGXS	GRIGIO TAGLIA XS	12
4TEESTAGS	GRIGIO TAGLIA S	12
4TEESTAGM	GRIGIO TAGLIA M	12
4TEESTAGL	GRIGIO TAGLIA L	12
4TEESTAGXL	GRIGIO TAGLIA XL	12
4TEESTAGXXL	GRIGIO TAGLIA XXL	12
4TEESTAG3XL	GRIGIO TAGLIA 3XL	12
4TEESTACXS	CASTAGNA TAGLIA XS	12
4TEESTACS	CASTAGNA TAGLIA S	12
4TEESTACM	CASTAGNA TAGLIA M	12
4TEESTACL	CASTAGNA TAGLIA L	12
4TEESTACXL	CASTAGNA TAGLIA XL	12
4TEESTACXXL	CASTAGNA TAGLIA XXL	12
4TEESTAC3XL	CASTAGNA TAGLIA 3XL	12

T-shirt Timaru

ASSENT®

100 % cotone, 180 g/m²

CODICE	DESCRIZIONE	Q.TÀ
4TIMARUGS	GRIGIO/NERO TAGLIA S	12
4TIMARUGM	GRIGIO/NERO TAGLIA M	12
4TIMARUGL	GRIGIO/NERO TAGLIA L	12
4TIMARUGXL	GRIGIO/NERO TAGLIA XL	12
4TIMARUGXXL	GRIGIO/NERO TAGLIA XXL	12
4TIMARUG3XL	GRIGIO/NERO TAGLIA 3XL	12



Pantalone Knoxfield multitasca

CERVA



EN ISO 13688

65 % poliestere, 35 % cotone, 320 g/m²

CODICE	DESCRIZIONE	Q.TÀ
4KNOXFIELDPAMULTI46	ANTRACITE TAGLIA 46	12
4KNOXFIELDPAMULTI48	ANTRACITE TAGLIA 48	12
4KNOXFIELDPAMULTI50	ANTRACITE TAGLIA 50	12
4KNOXFIELDPAMULTI52	ANTRACITE TAGLIA 52	12
4KNOXFIELDPAMULTI54	ANTRACITE TAGLIA 54	12
4KNOXFIELDPAMULTI56	ANTRACITE TAGLIA 56	12
4KNOXFIELDPAMULTI58	ANTRACITE TAGLIA 58	12
4KNOXFIELDPAMULTI60	ANTRACITE TAGLIA 60	12
4KNOXFIELDPAMULTI62	ANTRACITE TAGLIA 62	12
4KNOXFIELDPAMULTI64	ANTRACITE TAGLIA 64	12

Pantalone Knoxfield

CERVA



EN ISO 13688

65 % poliestere, 35 % cotone, 275 g/m²

CODICE	DESCRIZIONE	Q.TÀ
4KNOXFIELDPA46	ANTRACITE TAGLIA 46	12
4KNOXFIELDPA48	ANTRACITE TAGLIA 48	12
4KNOXFIELDPA50	ANTRACITE TAGLIA 50	12
4KNOXFIELDPA52	ANTRACITE TAGLIA 52	12
4KNOXFIELDPA54	ANTRACITE TAGLIA 54	12
4KNOXFIELDPA56	ANTRACITE TAGLIA 56	12
4KNOXFIELDPA58	ANTRACITE TAGLIA 58	12
4KNOXFIELDPA60	ANTRACITE TAGLIA 60	12
4KNOXFIELDPA62	ANTRACITE TAGLIA 62	12
4KNOXFIELDPA64	ANTRACITE TAGLIA 64	12

Pantalone Keilor

CERVA

EN ISO 13688

98 % cotone, 2 % elasthan, 265 g/m²

Disponibili anche nei colori illustrati

CODICE	DESCRIZIONE	Q.TÀ
4KEILORPABEIGE46	BEIGE TAGLIA 46	12
4KEILORPABEIGE48	BEIGE TAGLIA 48	12
4KEILORPABEIGE50	BEIGE TAGLIA 50	12
4KEILORPABEIGE52	BEIGE TAGLIA 52	12
4KEILORPABEIGE54	BEIGE TAGLIA 54	12
4KEILORPABEIGE56	BEIGE TAGLIA 56	12
4KEILORPABEIGE60	BEIGE TAGLIA 60	12
4KEILORPABEIGE62	BEIGE TAGLIA 62	12
4KEILORPAGREY46	GRIGIO TAGLIA 46	12
4KEILORPAGREY48	GRIGIO TAGLIA 48	12
4KEILORPAGREY50	GRIGIO TAGLIA 50	12
4KEILORPAGREY52	GRIGIO TAGLIA 52	12
4KEILORPAGREY54	GRIGIO TAGLIA 54	12
4KEILORPAGREY56	GRIGIO TAGLIA 56	12
4KEILORPAGREY58	GRIGIO TAGLIA 58	12
4KEILORPAGREY60	GRIGIO TAGLIA 60	12
4KEILORPAGREY62	GRIGIO TAGLIA 62	12

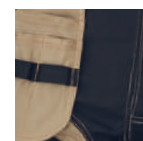
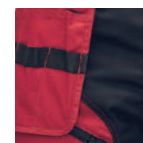

Shorts Keilor

CERVA

EN ISO 13688

98 % cotone, 2 % elasthan, 265 g/m²

Disponibili anche nei colori illustrati

CODICE	DESCRIZIONE	Q.TÀ
4KEILORSHORTBEIGE46	BEIGE TAGLIA 46	12
4KEILORSHORTBEIGE48	BEIGE TAGLIA 48	12
4KEILORSHORTBEIGE50	BEIGE TAGLIA 50	12
4KEILORSHORTBEIGE52	BEIGE TAGLIA 52	12
4KEILORSHORTBEIGE54	BEIGE TAGLIA 54	12
4KEILORSHORTBEIGE56	BEIGE TAGLIA 56	12
4KEILORSHORTBEIGE58	BEIGE TAGLIA 58	12
4KEILORSHORTBEIGE60	BEIGE TAGLIA 60	12
4KEILORSHORTBEIGE62	BEIGE TAGLIA 62	12
4KEILORSHORTGRIG46	GRIGIO TAGLIA 46	12
4KEILORSHORTGRIG48	GRIGIO TAGLIA 48	12
4KEILORSHORTGRIG50	GRIGIO TAGLIA 50	12
4KEILORSHORTGRIG52	GRIGIO TAGLIA 52	12
4KEILORSHORTGRIG54	GRIGIO TAGLIA 54	12
4KEILORSHORTGRIG56	GRIGIO TAGLIA 56	12
4KEILORSHORTGRIG58	GRIGIO TAGLIA 58	12
4KEILORSHORTGRIG60	GRIGIO TAGLIA 60	12
4KEILORSHORTGRIG62	GRIGIO TAGLIA 62	12

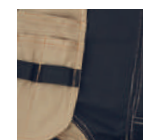
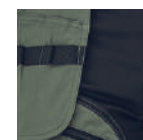
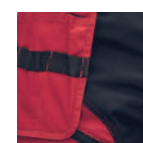

Crambe mimetici



EN ISO 13688

65 % poliestere, 35 % cotone, 190 g/m²

Disponibili anche nei colori illustrati

CODICE	DESCRIZIONE	Q.TÀ
4CRAMBES	TERRA TAGLIA S	12
4CRAMBEM	TERRA TAGLIA M	12
4CRAMBEL	TERRA TAGLIA L	12
4CRAMBEXL	TERRA TAGLIA XL	12
4CRAMBEXXL	TERRA TAGLIA XXL	12
4CRAMBEX3XL	TERRA TAGLIA 3XL	12
4CRAMBEGS	GRIGIO TAGLIA S	12
4CRAMBEGM	GRIGIO TAGLIA M	12
4CRAMB EGL	GRIGIO TAGLIA L	12
4CRAMBEGXL	GRIGIO TAGLIA XL	12
4CRAMBEGXXL	GRIGIO TAGLIA XXL	12
4CRAMBEG3XL	GRIGIO TAGLIA 3XL	12
4CRAMBEVS	PETROLIO TAGLIA S	12
4CRAMBEVM	PETROLIO TAGLIA M	12
4CRAMBEVL	PETROLIO TAGLIA L	12
4CRAMBEVXL	PETROLIO TAGLIA XL	12
4CRAMBEVXXL	PETROLIO TAGLIA XXL	12
4CRAMBEV3XL	PETROLIO TAGLIA 3XL	12
4CRAMBETSHIRTGM	GRIGIO TAGLIA M T-SHIRT	12
4CRAMBETSHIRTGL	GRIGIO TAGLIA L T-SHIRT	12
4CRAMBETSHIRTGXL	GRIGIO TAGLIA XL T-SHIRT	12
4CRAMBETSHIRTGXXL	GRIGIO TAGLIA XXL T-SHIRT	12
4CRAMBETSHIRTG3XL	GRIGIO TAGLIA 3XL T-SHIRT	12

Gilet Crambe mimetico camouflage



EN ISO 13688

65 % poliestere, 35 % cotone, 190 g/m²

CODICE	DESCRIZIONE	Q.TÀ
4CRAMBECAMOS	GILET TAGLIA S	12
4CRAMBECAMOM	GILET TAGLIA M	12
4CRAMBECAMO I	GILET TAGLIA I	12
4CRAMBECAMOXL	GILET TAGLIA XL	12
4CRAMBECAMOXXL	GILET TAGLIA XXL	12
4CRAMBECAMO3XL	GILET TAGLIA 3XL	12

Giacca Boyer

100 % poliestere, 265 g/m²

Giacca da uomo con cerniera in poliestere, con spalle e maniche rinforzate, 1 tasca sul petto con cerniera, 2 tasche laterali con cerniera, orlo inferiore regolabile tramite cordino e foro per il pollice sul polsino della manica.



CODICE	DESCRIZIONE	Q.TÀ
4BOYERBEIGE	BEIGE TAGLIA XS- 3XL	12
4BOYERGRIGIA	GRIGIA TAGLIA XS- 3XL	12
4BOYERRED	ROSSA TAGLIA XS- 3XL	12
4BOYERBLU	BLU TAGLIA XS- 3XL	12
4BOYERVERDE	VERDE TAGLIA XS- 3XL	12

Giacca Huyer softshell impermeabile traspirante



NEW

CODICE	DESCRIZIONE	Q.TÀ
4HUYERGXS	HUYER GRIGIA TAGLIA XS	12
4HUYERGS	HUYER GRIGIA TAGLIA S	12
4HUYERGM	HUYER GRIGIA TAGLIA M	12
4HUYERGI	HUYER GRIGIA TAGLIA I	12
4HUYERGXL	HUYER GRIGIA TAGLIA XL	12
4HUYERGXXL	HUYER GRIGIA TAGLIA XXL	12

CODICE	DESCRIZIONE	Q.TÀ
4HUYERBXS	HUYER BEIGE TAGLIA XS	12
4HUYERBS	HUYER BEIGE TAGLIA S	12
4HUYERBM	HUYER BEIGE TAGLIA M	12
4HUYERBI	HUYER BEIGE TAGLIA I	12
4HUYERBXL	HUYER BEIGE TAGLIA XL	12
4HUYERBXXL	HUYER BEIGE TAGLIA XXL	12

Gilet Montrose hv bodywarmer
riflettente isolante

CERVA



100% poliestere, 120 gsm

ISO 13688
EN ISO 20471

CODICE	DESCRIZIONE	Q.TÀ
4MONTROSEHVGS	MONTROSE GIALLA TAGLIA S	12
4MONTROSEHVGM	MONTROSE GIALLA TAGLIA M	12
4MONTROSEHVGI	MONTROSE GIALLA TAGLIA I	12
4MONTROSEHVGXL	MONTROSE GIALLA TAGLIA XL	12
4MONTROSEHVGXXL	MONTROSE GIALLA TAGLIA XXL	12
4MONTROSEHVGS3XL	MONTROSE GIALLA TAGLIA 3XL	12
CODICE	DESCRIZIONE	Q.TÀ
4MONTROSEHVAS	MONTROSE ARANCIONE TAGLIA S	12
4MONTROSEHVAM	MONTROSE ARANCIONE TAGLIA M	12
4MONTROSEHVAI	MONTROSE ARANCIONE TAGLIA I	12
4MONTROSEHVAXL	MONTROSE ARANCIONE TAGLIA XL	12
4MONTROSEHVAXXL	MONTROSE ARANCIONE TAGLIA XXL	12
4MONTROSEHVAS3XL	MONTROSE ARANCIONE TAGLIA 3XL	12

Gilet max neo light vest antivento impermeabile



100% poliestere, 200 gsm

ISO 13688

CODICE	DESCRIZIONE	Q.TÀ
4MAXNEOBS	MAX NEO LIGHT BIANCA TAGLIA S	12
4MAXNEOBM	MAX NEO LIGHT BIANCA TAGLIA M	12
4MAXNEOBI	MAX NEO LIGHT BIANCA TAGLIA I	12
4MAXNEOBXL	MAX NEO LIGHT BIANCA TAGLIA XL	12
4MAXNEOBXXL	MAX NEO LIGHT BIANCA TAGLIA XXL	12
4MAXNEOB3XL	MAX NEO LIGHT BIANCA TAGLIA 3XL	12
CODICE	DESCRIZIONE	Q.TÀ
4MAXNEOGS	MAX NEO LIGHT GRIGIA TAGLIA S	12
4MAXNEOGM	MAX NEO LIGHT GRIGIA TAGLIA M	12
4MAXNEOGI	MAX NEO LIGHT GRIGIA TAGLIA I	12
4MAXNEOGXL	MAX NEO LIGHT GRIGIA TAGLIA XL	12
4MAXNEOGXXL	MAX NEO LIGHT GRIGIA TAGLIA XXL	12
4MAXNEO3XL	MAX NEO LIGHT GRIGIA TAGLIA 3XL	12

Giubbotto con cappuccio Allyn



EN ISO 13688

65 % poliestere, 35 % cotone, 290 g/m²

CODICE	DESCRIZIONE	Q.TÀ
4ALLYNGIUBG/NXS	GRIGIO TAGLIA XS	12
4ALLYNGIUBG/NS	GRIGIO TAGLIA S	12
4ALLYNGIUBG/NM	GRIGIO TAGLIA M	12
4ALLYNGIUBG/NL	GRIGIO TAGLIA L	12
4ALLYNGIUBG/NXL	GRIGIO TAGLIA XL	12
4ALLYNGIUBG/NXXL	GRIGIO TAGLIA XXL	12
4ALLYNGIUBG/N3XL	GRIGIO TAGLIA 3XL	12

Giacca Knoxfield primaverile



EN ISO 13688

100 % poliestere, rivestimento: TPU 290 g/m²

CODICE	DESCRIZIONE	Q.TÀ
4KNOXFIELDGIAGXS	GIALLA TAGLIA XS	12
4KNOXFIELDGIAGS	GIALLA TAGLIA S	12
4KNOXFIELDGIAGM	GIALLA TAGLIA M	12
4KNOXFIELDGIAGL	GIALLA TAGLIA L	12
4KNOXFIELDGIAGXL	GIALLA TAGLIA XL	12
4KNOXFIELDGIAGXXL	GIALLA TAGLIA XXL	12
4KNOXFIELDGIAG3XL	GIALLA TAGLIA 3XL	12

Pantalone alta visibilità Knoxfield



65 % poliestere, 35 % cotone, 275 g/m²

CODICE	DESCRIZIONE	Q.TÀ
4KNOXFIELDHVPAG46	ANTRACITE HV TAGLIA 46	12
4KNOXFIELDHVPAG48	ANTRACITE HV TAGLIA 48	12
4KNOXFIELDHVPAG50	ANTRACITE HV TAGLIA 50	12
4KNOXFIELDHVPAG52	ANTRACITE HV TAGLIA 52	12
4KNOXFIELDHVPAG54	ANTRACITE HV TAGLIA 54	12
4KNOXFIELDHVPAG56	ANTRACITE HV TAGLIA 56	12
4KNOXFIELDHVPAG58	ANTRACITE HV TAGLIA 58	12
4KNOXFIELDHVPAG60	ANTRACITE HV TAGLIA 60	12
4KNOXFIELDHVPAG62	ANTRACITE HV TAGLIA 62	12
4KNOXFIELDHVPAG64	ANTRACITE HV TAGLIA 64	12

Giacca Emerton winter



EN ISO 13688

94 % poliestere, 6 % elasthan, 320 g/m²

CODICE	DESCRIZIONE	Q.TÀ
4EMERTONWINTERGIAS	NERA TAGLIA S	12
4EMERTONWINTERGIAM	NERA TAGLIA M	12
4EMERTONWINTERGIAL	NERA TAGLIA L	12
4EMERTONWINTERGIAXL	NERA TAGLIA XL	12
4EMERTONWINTERGIAXXL	NERA TAGLIA XXL	12
4EMERTONWINTERGIA3XL	NERA TAGLIA 3XL	12

Giacca alta visibilità malabar



EN 343

100% poliestere

CODICE	DESCRIZIONE	Q.TÀ
4MALABARGIAGS	GIALLA TAGLIA S	12
4MALABARGIAGM	GIALLA TAGLIA M	12
4MALABARGIAGL	GIALLA TAGLIA L	12
4MALABARGIAGXL	GIALLA TAGLIA XL	12
4MALABARGIAGXXL	GIALLA TAGLIA XXL	12
4MALABARGIAG3XL	GIALLA TAGLIA 3XL	12

Salopette Padstow gialla hv



EN ISO 13688



EN 343
(31X)



EN 342
(Icler_3WP)



EN ISO 20471
(Classe: 2)

100% poliestere

CODICE	DESCRIZIONE	Q.TÀ
4PADSTOWSAGHVS	GIALLA TAGLIA S	12
4PADSTOWSAGHVM	GIALLA TAGLIA M	12
4PADSTOWSAGHVL	GIALLA TAGLIA L	12
4PADSTOWSAGHVXL	GIALLA TAGLIA XL	12
4PADSTOWSAGHVXXL	GIALLA TAGLIA XXL	12
4PADSTOWSAGHV3XL	GIALLA TAGLIA 3XL	12

Giubbotto di segnalazione



EN ISO 13688



EN ISO 20471
(Classe: 2)

100 % poliestere, 130 g/m²

CODICE	DESCRIZIONE	Q.TÀ
4BRUNOARANCIO	ARANCIO HV	50
4BRUNOGIALLO	GIALLO HV	50

Giubbotto di segnalazione con tasche

EN ISO 13688



EN ISO 20471
(Classe: 1)

100 % poliestere, 130 g/m²



CODICE	DESCRIZIONE	Q.TÀ
4LYNXPROFIVEST-S	TAGLIA S	50
4LYNXPROFIVEST-M	TAGLIA M	50
4LYNXPROFIVEST-L	TAGLIA L	50
4LYNXPROFIVEST-XL	TAGLIA XL	50
4LYNXPROFIVEST-XXL	TAGLIA XXL	50
4LYNXPROFIVEST-3XL	TAGLIA 3XL	50

Polo Cadiz



EN ISO 13688



EN ISO 20471
(Classe: 1)

100 % poliestere, 160 g/m²

NEW

CODICE	DESCRIZIONE	Q.TÀ
4CADIZGM	GIALLA TAGLIA M	12
4CADIZGL	GIALLA TAGLIA L	12
4CADIZGXL	GIALLA TAGLIA XL	12
4CADIZGXXL	GIALLA TAGLIA XXL	12
4CADIZG3XL	GIALLA TAGLIA 3XL	12

Polo Cadiz



EN ISO 13688



EN ISO 20471
(Classe: 1)

100 % poliestere, 160 g/m²

NEW

CODICE	DESCRIZIONE	Q.TÀ
4CADIZAM	ARANCIONE TAGLIA M	12
4CADIZAL	ARANCIONE TAGLIA L	12
4CADIZAXL	ARANCIONE TAGLIA XL	12
4CADIZAXXL	ARANCIONE TAGLIA XXL	12
4CADIZA3XL	ARANCIONE TAGLIA 3XL	12

Tuta impermeabile

con cuciture elastiche



EN ISO 13688

100 % poliestere, 200 g/m², rivestimento: PVC

NEW

CODICE	DESCRIZIONE	Q.TÀ
4SIRETL	TAGLIA L	12
4SIRETXL	TAGLIA XL	12
4SIRETXXL	TAGLIA XXL	12

Impermeabile Siret



EN ISO 13688



EN 343
(31)



EN ISO 20471
(Classe: 3)

100 % poliestere, 200 g/m², rivestimento: poliuretano

NEW

CODICE	DESCRIZIONE	Q.TÀ
4SIRETHVL	SIRET GIALLA TAGLIA L	12
4SIRETHVXL	SIRET GIALLA TAGLIA XL	12
4SIRETHVXXL	SIRET GIALLA TAGLIA XXL	12
4GORDONHVM	GORDON GIALLA TAGLIA M	12
4GORDONHVL	GORDON GIALLA TAGLIA L	12
4GORDONHVXL	GORDON GIALLA TAGLIA XL	12
4GORDONHVXXL	GORDON GIALLA TAGLIA XXL	12

Cappotto anti pioggia impermeabile



EN ISO 13688

100 % poliestere, rivestimento: PVC

ANTIVENTO

ANTIPIOGGIA

CODICE	DESCRIZIONE	Q.TÀ
4NEPTUNM	TAGLIA M	12
4NEPTUNL	TAGLIA L	12
4NEPTUNXL	TAGLIA XL	12
4NEPTUNXXL	TAGLIA XXL	12

Poncho pvc



100 % PVC, rivestimento: TPU

ANTIVENTO

ANTIPIOGGIA

CODICE	DESCRIZIONE	Q.TÀ
4PONCHO	PONCHO PVC VERDE	12
4PONCHOGI	PONCHO PVC GIALLO	12

Set anti pioggia Carina verde

CERVA



EN ISO 13688

100 % poliestere, rivestimento: PVC

ANTIVENTO

ANTIPIOGGIA

CODICE	DESCRIZIONE	Q.TÀ
4CARINAVERDEM	TAGLIA M	12
4CARINAVERDEL	TAGLIA L	12
4CARINAVERDEXL	TAGLIA XL	12
4CARINAVERDEXXL	TAGLIA XXL	12

Set anti pioggia carina mimetico

CERVA



EN ISO 13688

100 % poliestere, rivestimento: PVC

ANTIVENTO

ANTIPIOGGIA

CODICE	DESCRIZIONE	Q.TÀ
4CARINAMIMETICOM	TAGLIA M	12
4CARINAMIMETICOM	TAGLIA L	12
4CARINAMIMETICOM	TAGLIA XL	12
4CARINAMIMETICOM	TAGLIA XXL	12
4CARINAMIMETICOM	TAGLIA 3XL	12

Cintura Billum nera



CODICE	DESCRIZIONE	Q.TÀ
4BILLUM105	105 CM	20
4BILLUM135	135 CM	20

Cintura con fibbia metallica

cuoio extra rifinito

BREMAK



CODICE	DESCRIZIONE	Q.TÀ
BK9310	PELLE PIENO FIORE- 127 CM	10

Porta-cutter e porta-marcatore

BREMAK



NEW

CODICE	DESCRIZIONE	Q.TÀ
4FILTERSPECPRO	SET 3 MASCHERE FFP2 FILTRO CON OCCHIALE	10

Borsa carpentiere vera pelle

BREMAK



NEW

CODICE	DESCRIZIONE	Q.TÀ
C0017	FFP2	10

Cuffia antirumore



EN352-1:2002

23DB

CODICE	DESCRIZIONE	Q.TÀ
C0008	23 DB	12

Cuffia antirumore



CODICE	DESCRIZIONE	Q.TÀ
C0011	CUFFIA ANTIRUMORE	12

Cuffie per casco



EN352-3:2003

23DB

CODICE	DESCRIZIONE	Q.TÀ
C0061	23 DB	10

Cuffia antirumore



CODICE	DESCRIZIONE	Q.TÀ
C0009	CUFFIA ANTIRUMORE	12

Visiera protettiva professionale



CODICE	DESCRIZIONE	Q.TÀ
C0076	PROFESSIONALE CON SCHERMO IN RETE	10

Casco da elettricista a cappello



EN 812

NEW



CODICE	DESCRIZIONE	Q.TÀ
4HARTEBEESTARANCIO	ARANCIONE	10
4HARTEBEESTGIALLO	GIALLO	10

Casco a led



EN 812
RoHS

NEW

CODICE	DESCRIZIONE	Q.TÀ
4CAPLED	CASCO A LED	12

Cuffia antirumore ciron advance

CERVA



EN 352-1

217G

32DB

CODICE	DESCRIZIONE	Q.TÀ
4CIRONADVANCE	32 DB	10

Casco in hdpe con sottonto



EN 397 + A1:2013

CODICE	DESCRIZIONE	Q.TÀ
C0040	BIANCO	10
C0041	GIALLO	10
C0042	BLU	10
TO-74191	ROSSO	10

Visiera per casco in rete



CODICE	DESCRIZIONE	Q.TÀ
C0062	VISIERA PER CASCO IN RETE	10

Elmetto wr ventilato hv

CERVA



EN 166
EN 172
EN 170
EN 397

460G

53-66
CM

-30 °C a
+50 °C

CODICE	DESCRIZIONE	Q.TÀ
4ALPINWORKERELMROSS	ROSSO HV	10
4ALPINWORKELMOBIANCO	BIANCO HV	10
4ALPINWORKELMOGIALLO	GIALLO HV	10
4ALPINWORKELMOBLU	BLU HV	10

Sottogola per elmetto alpin

CERVA



CODICE	DESCRIZIONE	Q.TÀ
4ALPINSOTTOGOLA	SOTTOGOLA PER ELMETTO ALPIN	10

Cuffie antirumore

CERVA



ALPIN 300G 32DB

CE
EN 352-3

CODICE	DESCRIZIONE	Q.TÀ
4CIRONHELMET	32 DB	10

Visiera a occhiale per elmetto alpin

CERVA



ALPIN

CE

EN 166
EN 170

CODICE	DESCRIZIONE	Q.TÀ
4ALPINVISIERA	VISIERA A OCCHIALE PER ELMETTO ALPIN	10

Ginocchiera in gel exclusive

RICHMANN



NEW

CODICE	DESCRIZIONE	Q.TÀ
C0036	GINOCCHIERA IN GEL	10

Ginocchiera antiaffaticamento

RICHMANN



NEW

CODICE	DESCRIZIONE	Q.TÀ
C0035	GINOCCHIERA ANTIAFFATICAMENTO	10

Ginocchiera flessibile
con fissaggio a strappo

RICHMANN



CE

CODICE	DESCRIZIONE	Q.TÀ
C0007	GINOCCHIERA FLESSIBILE FISSAGGIO STRAPPO	10

Ginocchiera flessibile
con fissaggio a strappo in gel

RICHMANN



CE

CODICE	DESCRIZIONE	Q.TÀ
C0006	CON FISSAGGIO A STRAPPO IN GEL	10

Ginocchiera in gel



CODICE	DESCRIZIONE	Q.TÀ
C0037	GINOCCHIERA IN GEL	12

Soletta con cuscinetto in gel



CODICE	DESCRIZIONE	Q.TÀ
SOLETTAGEL-38	TAGLIA 38	12
SOLETTAGEL-39	TAGLIA 39	12
SOLETTAGEL-40	TAGLIA 40	12
SOLETTAGEL-41	TAGLIA 41	12
SOLETTAGEL-42	TAGLIA 42	12
SOLETTAGEL-43	TAGLIA 43	12
SOLETTAGEL-44	TAGLIA 44	12
SOLETTAGEL-45	TAGLIA 45	12
SOLETTAGEL-46	TAGLIA 46	12
SOLETTAGEL-47	TAGLIA 47	12

Mascherina monouso a conchiglia

Con valvola



EN149:2001+A1:2009

CODICE	DESCRIZIONE	Q.TÀ
C0012	FFP1	10
C0014	FFP2	10

Mascherina monouso a conchiglia

Con valvola



EN149:2001+A1:2009

CODICE	DESCRIZIONE	Q.TÀ
C0015	FFP3	10

Set 3 maschere ffp2 filtro

con occhiale



CODICE	DESCRIZIONE	Q.TÀ
4FILTERSPECPRO	SET 3 MASCHERE FFP2 CON OCCHIALE	10

Mascherina con valvola



CODICE	DESCRIZIONE	Q.TÀ
C0017	FFP2	10

Imbragatura di sicurezza



EN 361:2002

NEW

CODICE	DESCRIZIONE		Q.TÀ
YT-74220	NASTRI 45 mm	RESISTENZA 27 KN	10

Occhiali sicurezza regolabili



EN166:2002

CODICE	DESCRIZIONE	Q.TÀ
C0000	REGOLABILI NERI	10
C0001	REGOLABILI GIALLI	10
C0002	REGOLABILI TRASPARENTI	10
C0005	NON REGOLABILI TRASPARENTI	10

Occhiali protettivi da lavoro



EN14 EN 166 1 F
EN 172 5-3.1
ANSI/ISEA Z87 .1 + U6
ANSI/ISEA Z87 .1 + U6 L3
AS/NZS 1337.1
9:2001+A1:2009

NEW

CODICE	DESCRIZIONE	Q.TÀ
C0026	CON LENTI SOLARI	10
4PARISCLEAR	CON LENTI TRASPARENTI	12

Tappi auricolari 33db



EN352-2:2002

33DB

CODICE	DESCRIZIONE	Q.TÀ
C0030	33 DB	50

Tappi auricolari 35db con cordino



EN352-2:2002

35DB

CODICE	DESCRIZIONE	Q.TÀ
C0031	35 DB	50

Gilet invernale Montrose hv



 **BREMAK®**

**MATITA
AUTOMATICA
Ø 2,8 mm**

- ALTA PRECISIONE DI SEGNO
- COMPLETA DI TEMPERINO
- PUNTA SEMPRE PERFETTA
- MARCATURA FORI PROFONDI
- CLIP DI AGGANCO
- CUSTODIA DI PROTEZIONE
- SCRIVE SU TUTTE LE SUPERFICIE



 **BREMAK®**

 **BREMAK®**

COD. BK7100

**BOX 12 MATITE AUTOMATICHE
+ 12 MINE ASSORTITE**

**MATITA AUTOMATICA
Ø 2,8 mm**

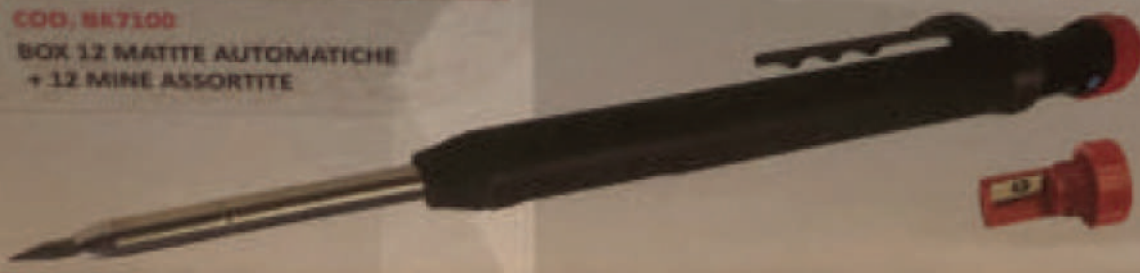

EDILIZIA

Blister matita da falegname

Hb + 3 ricariche



X3 HB

CODICE	DESCRIZIONE	Q.TÀ
BK7110	MATITA AUTOMATICA D. 2,8 mm	10

Blister matita da falegname

Hb + 3 ricariche



CODICE	DESCRIZIONE	Q.TÀ
C0126	BLISTER MATITA DA FALEGNAME ROSSA HB + 3 RICARICHE	10

Matita carpentiere e temperino



HB

CODICE	DESCRIZIONE	Q.TÀ
C0124	MATITA DA CARPENTIERE ROSSO 25CM 3PZ + TEMPERINO	4

Ricarica per matita meccanica



X5 4H HB

CODICE	DESCRIZIONE	Q.TÀ
C0127	ROSSA HB C0126 CONFEZIONE DA 5PZ	5

Matita del falegname



X55 HB 25 CM

CODICE	DESCRIZIONE	Q.TÀ
C0125	LUNGHEZZA 25 CM (BOX 55PZ)	4

Matita del muratore



X55 4H 25 CM

CODICE	DESCRIZIONE	Q.TÀ
C0225	LUNGHEZZA 25 CM (BOX 55PZ)	4

Box mine automatiche

12 mine assortite



CODICE	DESCRIZIONE	Q.TÀ
BK7100	BOX 12 MATITE + 12 MINE	12

Mine di ricambio matita



X3 HB

CODICE	DESCRIZIONE	Q.TÀ
BK7120	MINE RICAMBIO MATITA AUTOMATICA GRIGIO GRAFITE	6

Mine di ricambio matita



X3 HB

CODICE	DESCRIZIONE	Q.TÀ
BK7130	MINE RICAMBIO MATITA AUTOMATICA ROSSO CERATA	3

Mina di ricambio matita



X3 HB

CODICE	DESCRIZIONE	Q.TÀ
BK7140	MINE RICAMBIO MATITA AUTOMATICA GIALLO CERATA	3

Filo altissima resistenza

intrecciato indemagliabile

**Filo altissima resistenza**

intrecciato indemagliabile



CODICE	DESCRIZIONE	Q.TÀ
BK7050	GIALLO E ROSSO 100MT Ø1,5 mm	15

CODICE	DESCRIZIONE	Q.TÀ
BK7060	BIANCO NERO E ROSSO 100MT Ø1,5 mm	15

Filo altissima resistenza

intrecciato indemagliabile



CODICE	DESCRIZIONE	Q.TÀ
BK7055	GIALLO E ROSSO 100MT Ø2,5 mm	15

Filo altissima resistenza

intrecciato indemagliabile



CODICE	DESCRIZIONE	Q.TÀ
BK7065	BIANCO NERO E ROSSO 100MT Ø2,5 mm	15

Matita del muratore e temperino



X55 4H 25 CM

CODICE	DESCRIZIONE	Q.TÀ
C0225	LUNGHEZZA 25 CM (BOX 55PZ)	4

Fessurimetro a parete e angolo

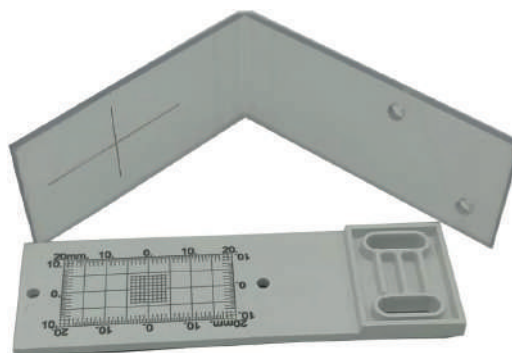

CODICE	DESCRIZIONE	Q.TÀ
BK6900	FESSURIMETRO A PARETE	10
BK6901	FESSURIMETRO AD ANGOLO	10

Filo muratore ø1,7 mm



50MT ø 1.7 mm

CODICE	DESCRIZIONE	Q.TÀ
C3601	4 COLORI (VIOLA, AZZURRO, GIALLO E ROSSO) 50MT	24
C3600	ø1,7 mm RULLO 4 COLORI 30MT	24

Filo da muratore ø1,7 mm



100MT ø 1.7 mm

CODICE	DESCRIZIONE	Q.TÀ
C3612	ARANCIONE E GIALLO 100MT	48

Tracciatore 30mt con ricarica



30MT 115G

CODICE	DESCRIZIONE	Q.TÀ
C3620	TRACCIATORE 30MT CON RICARICA DI 115G	12

Tempera matite



4H HB

CODICE	DESCRIZIONE	Q.TÀ
C0119	TEMPERA MATITE CARPENTIRE E MURATORE	4

Marcatore professionale nero



NEW

GRANDEZZA TRATTO 1:1

BOX
12 pezzi

PER TUTTE LE
SUPERFICI

1mm

140
mm

CODICE	DESCRIZIONE	Q.TÀ
C0130	COLORE NERO	12

Marcatore professionale bianco



NEW

GRANDEZZA TRATTO 1:1

BOX
12 pezzi

PER TUTTE LE
SUPERFICI

2mm

145
mm

CODICE	DESCRIZIONE	Q.TÀ
C0146	MARCATORE PERMANENTE BIANCO PER EDILIZIA	12

Gessetto tecnico nero



NEW

BOX
12 pezzi

PER TUTTE LE
SUPERFICI

120X12
mm

CODICE	DESCRIZIONE	Q.TÀ
C0196	GESSETTO PROFESSIONALE	12

Gessetto tecnico giallo



NEW

BOX
12 pezzi

PER TUTTE LE
SUPERFICI

120X12
mm

CODICE	DESCRIZIONE	Q.TÀ
C0197	GESSETTO PROFESSIONALE	12

Gessetto tecnico rosso



NEW

BOX
12 pezzi

PER TUTTE LE
SUPERFICI

120X12
mm

CODICE	DESCRIZIONE	Q.TÀ
C0198	GESSETTO PROFESSIONALE	12

Gessetto tecnico bianco



NEW

BOX
12 pezzi

PER TUTTE LE
SUPERFICI

120X12
mm

CODICE	DESCRIZIONE	Q.TÀ
C0199	GESSETTO PROFESSIONALE	12

Miscelatore per vernice

Attacco esagonale

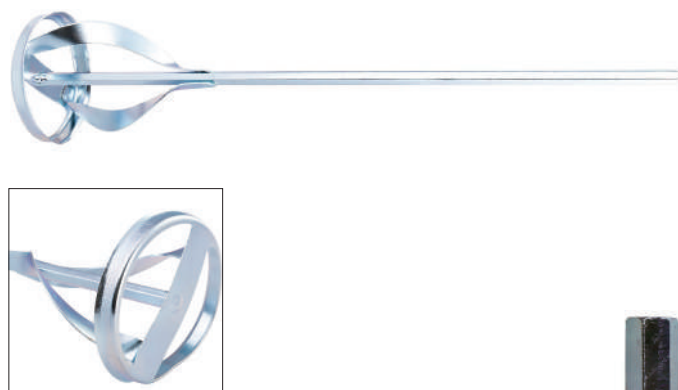

CODICE	DESCRIZIONE	Q.TÀ
C0601	400XØ80XØ8 mm MASSA 1-15KG	12

Miscelatore per vernice

Attacco esagonale

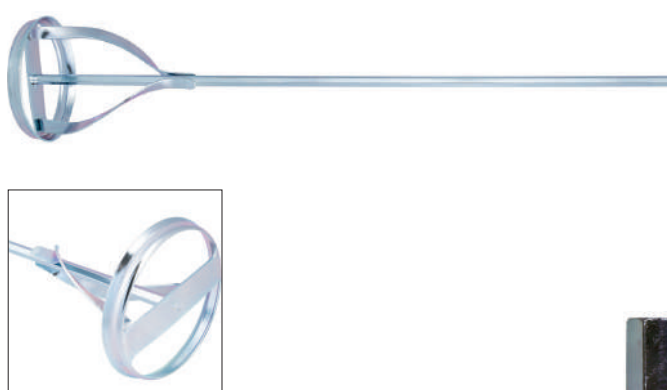

CODICE	DESCRIZIONE	Q.TÀ
C0602	500XØ100XØ8 mm MASSA 13-35KG	12

Miscelatore per gesso

Attacco esagonale

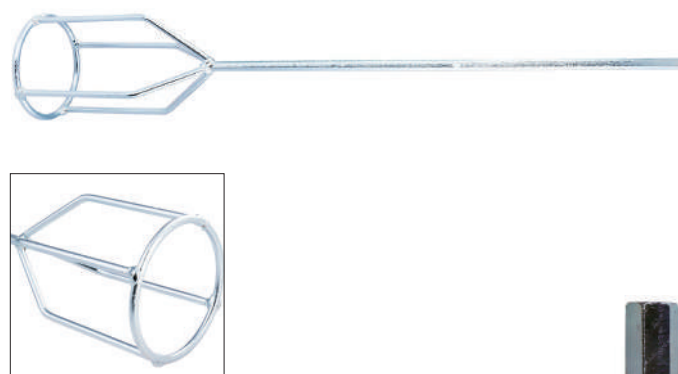

CODICE	DESCRIZIONE	Q.TÀ
C0611	500XØ80XØ8 mm MASSA 1-15KG	12
C0612	550XØ100XØ8 mm MASSA 13-35KG	12

Miscelatore per malta

Attacco esagonale

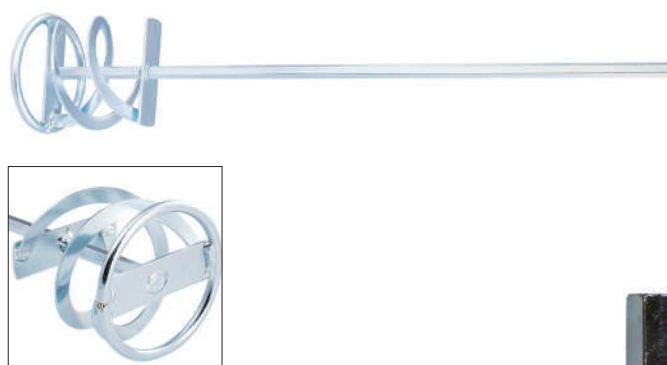

CODICE	DESCRIZIONE	Q.TÀ
C0631	400XØ80XØ8 mm MASSA 1-10KG	12
C0632	500XØ100XØ8 mm MASSA 10-25KG	12
C0633	600XØ110XØ8 mm MASSA 20-35KG	12

Miscelatore per malta

Attacco m14



CODICE	DESCRIZIONE	Q.TÀ
C0635	600XØ120 mm M14 MASSA 20-35KG	12
C0636	600XØ140 mm M14 MASSA 25-40KG	12
C0637	600XØ160 mm M14 MASSA 30-50KG	12

Miscelatore per malta

Attacco sds plus



CODICE	DESCRIZIONE	Q.TÀ
C0638	500XØ100 10 SDS PLUS MASSA 10-25KG	12
C0639	600XØ120 10SDS PLUS MASSA 20-35KG	12

Frattoni professionali in acciaio inossidabile

Modello italiano

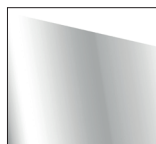

ACCIAIO INOX 0.7 mm

CODICE	DESCRIZIONE	Q.TÀ
C0556	280X130 mm ITALIANO	6

Frattoni professionali in acciaio inossidabile

Smussato

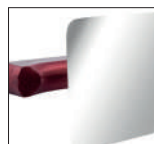

ACCIAIO INOX 0.7 mm

CODICE	DESCRIZIONE	Q.TÀ
C0549	200X100 mm	6

Frattoni professionali dentati in acciaio inossidabile



ACCIAIO INOX 0.8 mm

CODICE	DESCRIZIONE	Q.TÀ
C0553	280X130 mm DENTE 8X8 mm	6
C0554	280X130 mm DENTE 10X10 mm	6
C0555	280X130 mm DENTE 12X12 mm	6

Frattoni professionali in acciaio inossidabile

Modello italiano



ACCIAIO INOX

CODICE	DESCRIZIONE	Q.TÀ
C0557	400X130 mm ITALIANO	6
C0558	480X130 mm ITALIANO	6
C0559	580X130 mm ITALIANO	6

Frattoni professionali dentati in acciaio inossidabile

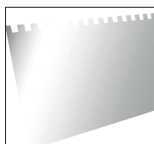

ACCIAIO INOX 0.9 mm

CODICE	DESCRIZIONE	Q.TÀ
C0560	480X130 mm DENTE 4X4 mm	6
C0561	480X130 mm DENTE 6X6 mm	6
C0562	480X130 mm DENTE 8X8 mm	6
C0563	480X130 mm DENTE 10X10 mm	6
C0564	480X130 mm DENTE 12X12 mm	6

Frattoni professionali in inox

Modello italiano

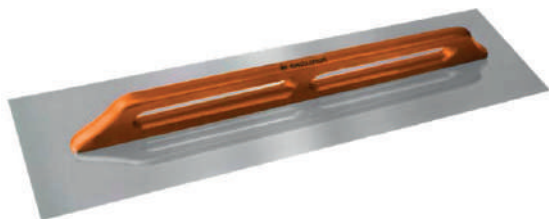

ACCAIO
INOX

CODICE	DESCRIZIONE	Q.TÀ
C0565	680X130 mm MODELLO ITALIANO	6

Frattoni pvc spugna leggera



20 mm

CODICE	DESCRIZIONE	Q.TÀ
C0521	270X130 mm	6

Frattoni pvc spugna densa



25 mm

CODICE	DESCRIZIONE	Q.TÀ
C0522	270X130 mm	6

Frattoni pvc ergonomico in gomma



7 mm

CODICE	DESCRIZIONE	Q.TÀ
C0523	270X130 mm	6

Frattoni pvc ergonomico in feltro



6 mm

CODICE	DESCRIZIONE	Q.TÀ
C0524	270X130 mm	6

Cazzuola trapezoidale



ACCAIO
INOX

1 mm

CODICE	DESCRIZIONE	Q.TÀ
C0586	LUNGHEZZA 160 mm	5
C0587	LUNGHEZZA 140 mm	5

Cazzuola trapezoidale manico

Professionale



ACCIAIO INOX 0.7 mm

CODICE	DESCRIZIONE	Q.TÀ
C0575	LUNGHEZZA 100 mm INOX	5
C0576	LUNGHEZZA 140 mm INOX	5
C0577	LUNGHEZZA 160 mm INOX	5
C0578	LUNGHEZZA 180 mm INOX	5

Espositore da banco

spatole e cazzuole



ACCIAIO INOX

CODICE	DESCRIZIONE	Q.TÀ
CZ05	ESPOSITORE DA BANCO 25 PZ	1

Spatola in faggio



ACCIAIO INOX 0.6 mm

CODICE	DESCRIZIONE	Q.TÀ
C9160	LUNGHEZZA 60 mm	10
C9161	LUNGHEZZA 80 mm	10
C9162	LUNGHEZZA 100 mm	10
C9163	LUNGHEZZA 120 mm	10
C9164	LUNGHEZZA 150 mm	10
C9165	LUNGHEZZA 200 mm	10

Spatola per stuccatori



ACCIAIO INOX 1.2 mm

CODICE	DESCRIZIONE	Q.TÀ
C0590	LUNGHEZZA 60 mm	5
C0591	LUNGHEZZA 80 mm	5
C0592	LUNGHEZZA 100 mm	5

Spatola



ACCIAIO INOX 0.7 mm

CODICE	DESCRIZIONE	Q.TÀ
C9150	LUNGHEZZA 40 mm	12
C9151	LUNGHEZZA 60 mm	12
C9152	LUNGHEZZA 80 mm	12
C9153	LUNGHEZZA 100 mm	12
C9154	LUNGHEZZA 120 mm	12

Martello in legno



NEW

CODICE	DESCRIZIONE	Q.TÀ
C2444	360 GR	6

Martello in legno

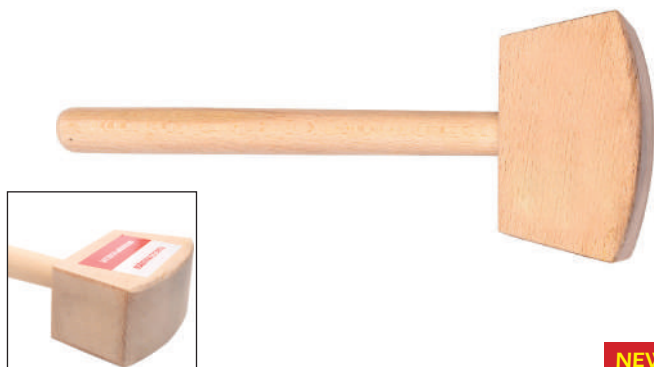

NEW

CODICE	DESCRIZIONE	Q.TÀ
C2445	460 GR	6

Teste di ricambio C2640



NEW

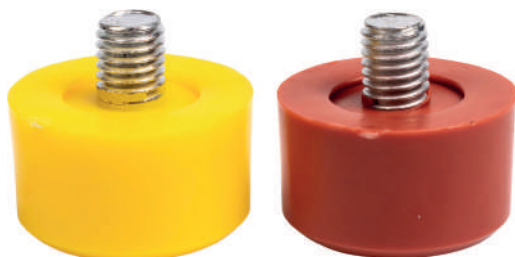

CODICE	DESCRIZIONE	Q.TÀ
C2643	Ø30 mm	1
C2644	Ø35 mm	1
C2645	Ø40 mm	1

Martello in vetroresina



DIN 1041

CODICE	DESCRIZIONE	Q.TÀ
C2501	100 GR	6
C2502	200 GR	6
C2503	300 GR	6
C2505	500 GR	6
C2508	800 GR	6
C2510	1 KG	6
C2515	1,5 KG	6
C2520	2 KG	6

Martello in gomma

Manico in legno



NEW



CODICE	DESCRIZIONE	Q.TÀ
C2640	Ø TESTA 30 mm	1
C2641	Ø TESTA 35 mm	1
C2642	Ø TESTA 40 mm	1

Martello in vetroresina e gomma



CODICE	DESCRIZIONE	Q.TÀ
C2606	Ø60 mm DA 665 GR	6
C2609	Ø90 mm DA 910 GR	6
C2612	Ø115 mm DA 1100 GR	6

Martello in vetroresina manico lungo

Manico in fibra di vetro



CODICE	DESCRIZIONE	Q.TÀ
C2521	3 KG	1
C2522	4 KG	1
C2523	5 KG	1

Martello in vetroresina per coperture



DIN 7239



CODICE	DESCRIZIONE	Q.TÀ
C2541	600 GR	6

Martello in vetroresina per muratore



DIN 5108



CODICE	DESCRIZIONE	Q.TÀ
C2542	600 GR	6

Mazzetta



DIN 6475



CODICE	DESCRIZIONE	Q.TÀ
C2455	1500 GR	6
C2456	2000 GR	6
C2458	RICAMBIO MAZZETTA 1500 GR C2455	6
C2459	RICAMBIO MAZZETTA 2000 GR C2456	6

Martello da carpentiere con magnete



CODICE	DESCRIZIONE	Q.TÀ
C2235	MARTELLINO DA carpentiere CON MAGNETE	6

Mazzetta con manico in vetroresina



NEW



DIN 6475



CODICE	DESCRIZIONE	Q.TÀ
CXT056R	1000 GR	12
CXT057R	1250 GR	12
CXT058R	1500 GR	12
CXT059R	2000 GR	12

Mazzetta con manico legno



NEW



DIN 1041

CODICE	DESCRIZIONE	Q.TÀ
CXT33039	1000 GR	12
CXT33040	1250 GR	12
CXT33041	1500 GR	12
CXT33042	2000 GR	12

Ascia in vetroresina



CODICE	DESCRIZIONE	Q.TÀ
C2580	600 GR	6
C2581	800 GR	6
C2582	1 KG	6
C2583	1,25 KG	6
C2584	1,5 KG	6

Ascia in vetroresina

Spacca legna



CODICE	DESCRIZIONE	Q.TÀ
C2586	1 KG	6
C2585	2,2 KG	6

Piede di porco



ACCIAIO
MN 65

CODICE	DESCRIZIONE	Q.TÀ
C5878	LUNGHEZZA 30 CM	1
C5879	LUNGHEZZA 45 CM	1
C5880	LUNGHEZZA 60 CM	1
C5881	LUNGHEZZA 75 CM	1
C5882	LUNGHEZZA 90 CM	1

Set cacciaspine



CODICE	DESCRIZIONE	Q.TÀ
C5801	SET CACCIASPINE 6PZ	10

Set scalpello e punzoni



CODICE	DESCRIZIONE	Q.TÀ
C5800	SET SCALPELLO E PUNZONI 3PZ	10

Set scalpello punzoni e cacciaspine



CODICE	DESCRIZIONE	Q.TÀ
C5803	SET SCALPELLO PUNZONI E CACCIASPINE 6PZ	10

Set scalpello punzoni e cacciaspine



CODICE	DESCRIZIONE	Q.TÀ
C5802	SET SCALPELLO PUNZONI E CACCIASPINE 12PZ	10

Scalpello taglio con paramano



CODICE	DESCRIZIONE	Q.TÀ
C5860	L 225 mm SP 19 mm LARGHEZZA 75 mm	6
C5865	L 300 mm SP 19 mm LARGHEZZA 22 mm	6
C5866	L 400 mm SP 19 mm LARGHEZZA 22 mm	6

Scalpello



CODICE	DESCRIZIONE	Q.TÀ
C5824	LUNGHEZZA 140 mm LARGHEZZA 8 mm	10
C5825	LUNGHEZZA 150 mm LARGHEZZA 10 mm	10
C5826	LUNGHEZZA 170 mm LARGHEZZA 12 mm	10

Punzone



CODICE	DESCRIZIONE	Q.TÀ
C5810	Ø6X100 mm	10
C5811	Ø8X115 mm	10

Cacciaspine



CODICE	DESCRIZIONE	Q.TÀ
C5815	Ø3X150 mm	10
C5816	Ø4X150 mm	10
C5817	Ø5X150 mm	10
C5818	Ø6X150 mm	10

CO493-CO494

nuova

VENTOSA PER VETRO IN ABS FINO A 120 KG



Ventosa singola di diametro 200 mm, capacità di 120 kg, manometro e pompa del vuoto.

Realizzata in materiale ABS, progettata per il trasporto e l'installazione di vetro, piastrelle in ceramica, lastre di metallo e plastica e altri oggetti con una superficie liscia o ruvida.

Una **vasta gamma di applicazioni** in svariati settori quali:

Carrozzeria e verniciatura, piastrellatura, vetro, falegnameria, industria, ecc.

Il **manometro** consente di controllare e regolare la pressione dell'aria all'interno della ventosa, che consente di regolare con precisione la forza della tenuta. Questo consente di aumentare la **sicurezza** e la **precisione** del lavoro durante la lavorazione del vetro o di altri materiali.

La pompa del vuoto consente di creare un vuoto tra la ventosa e la superficie del vetro, che si traduce in una presa stabile e duratura.

Ventose per vetro in abs

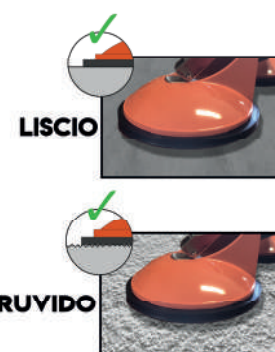

CODICE	DESCRIZIONE	Q.TÀ
C0493	FINO A 80 KG Ø 150 mm	6
C0494	FINO A 120 KG Ø 200 mm	6

80-120 KG Ø 150-200 mm

Ventose per vetro

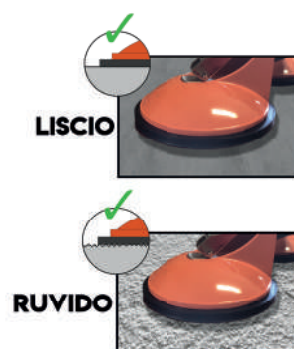

CODICE	DESCRIZIONE	Q.TÀ
C0491	FINO A 120 KG Ø 123 mm	6
C0492	FINO A 180 KG Ø 123 mm	6

80-120 KG Ø 150-200 mm

Pulisci fughe



CODICE	DESCRIZIONE	Q.TÀ
CZN37006	30 mm	20
CZN37007	50 mm	20

Ventosa per vetro



CODICE	DESCRIZIONE	Q.TÀ
CST38121	FINO A 25KG	6

**Chiave combinata cricchetto
Per ponteggi**



ACCIAIO
CRV

CODICE	DESCRIZIONE	Q.TÀ
C7496	DIMENSIONI CRICCHETTO 19X22	6

**Chiave combinata cricchetto
Per ponteggi a punta**

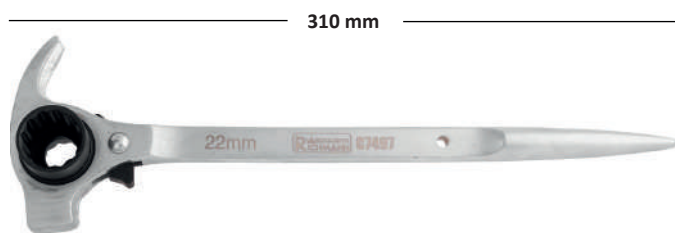

ACCIAIO
CRV

CODICE	DESCRIZIONE	Q.TÀ
C7497	DIMENSIONI CRICCHETTO 19X22	6

Tagliapiastrelle



NEW

CODICE	DESCRIZIONE	Q.TÀ
C8201	LUNGHEZZA 600 mm	6
C8204	LUNGHEZZA 800 mm	6
C8205	LUNGHEZZA 1000 mm	6
C8206	LUNGHEZZA 1200 mm	6

Secchio con becco



CODICE	DESCRIZIONE	Q.TÀ
C0652	CAPIENZA 12 LITRI	10
C0653	CAPIENZA 16 LITRI	10
C0654	CAPIENZA 20 LITRI	10

Contentore malta rettangolare



CODICE	DESCRIZIONE	Q.TÀ
C0660	CAPIENZA 40 LITRI	10
C0661	CAPIENZA 60 LITRI	10
C0662	CAPIENZA 90 LITRI	10

Contentore malta tondo



CODICE	DESCRIZIONE	Q.TÀ
C0663	CAPIENZA 40 LITRI	10
C0664	CAPIENZA 60 LITRI	10
C0665	CAPIENZA 90 LITRI	10

Distanziali croce per piastrelle



CODICE	DESCRIZIONE	Q.TÀ
CZN37149	1,5 mm (200PZ)	10
CZN37150	2 mm (200PZ)	10
CZN37151	2,5 mm (200PZ)	10
CZN37152	3 mm (150PZ)	10
CZN37153	4 mm (100PZ)	10
CZN37154	5 mm (75PZ)	10

Pistola termocollante



CODICE	DESCRIZIONE	Q.TÀ
C0845	PISTOLA TERMOCOLLANTE 60W CON REGOLATORE DI POTENZA FILO DA 1,5M	
	DIAMETRO CARTUCCIA	11 mm
	TENSIONE DI ALIMENTAZIONE	230V
	FREQUENZA NOMINALE	50HZ
	DIMENSIONI	170x145x30 mm

Pistola termocollante



CODICE	DESCRIZIONE	Q.TÀ
C0850	PISTOLA TERMOCOLLANTE CON REGOLATORE DI POTENZA 60W/100W E FILO DA 1,5M	
	DIAMETRO CARTUCCIA	11 mm
	TENSIONE DI ALIMENTAZIONE	230V
	FREQUENZA NOMINALE	50HZ
	DIMENSIONI	185X160X30 mm

Pistola termocollante



CODICE	DESCRIZIONE	Q.TÀ
C0851	PISTOLA TERMOCOLLANTE 150W CON REGOLATORE DI TEMPERATURA E FILO DA 1,5M	
	DIAMETRO CARTUCCIA	11 mm
	INTERVALLO DI TEMPERATURA	140/160/180/200/220 °C
	TENSIONE DI ALIMENTAZIONE	230V
	FREQUENZA NOMINALE	50HZ
	DIMENSIONI	195X160X40 mm

Colla termocollante in stick da 11 mm



CODICE	DESCRIZIONE	Q.TÀ
C0840	TRASPARENTE 1KG	5
C0841	NERA 1 KG	5

Pistola spara graffette



CODICE	DESCRIZIONE	Q.TÀ
C0805	GRAFFETTE IN METALLO 4-14 mm	6

Pistola spara graffette e sparachiodi in alluminio



ALLUMINIO

CODICE	DESCRIZIONE		Q.TÀ
C0800	PISTOLA SPARA GRAFFETTE 4-10 mm + SPARACHIODI 10 mm IN ALLUMINIO		6
	GRAFFETTE	TIPO 13: 4-10 mm	
		TIPO 53: 4-10 mm	
	CHIODI T	CHIODI T TIPO 8: 10 mm	
		CHIODI T TIPO 300: 10 mm	
DIMENSIONI	165X90X25 mm		

Pistola spara graffette e sparachiodi in alluminio



ALLUMINIO

CODICE	DESCRIZIONE		Q.TÀ
C0801	PISTOLA SPARA GRAFFETTE 4-10 mm + SPARACHIODI 10 mm IN ALLUMINIO		6
	GRAFFETTE	TIPO 13: 6-16 mm	
		TIPO 53: 6-16 mm	
	CHIODI T	CHIODI T TIPO 8: 16 mm	
		CHIODI T TIPO 300: 16 mm	
DIMENSIONI	180X100X30 mm		

Graffette tipo 53

TIPO
53

CODICE	DESCRIZIONE	Q.TÀ
C0806	6 mm	10
C0808	8 mm	10
C0810	10 mm	10
C0812	12 mm	10
C0814	14 mm	10

Nastro in pvc resistente ai raggi uv



CODICE	DESCRIZIONE	Q.TÀ
TO-75031	48 mmx33M	6

Nastro isolante in pvc



CODICE	DESCRIZIONE	Q.TÀ
C1940	NERO 19 mmx10M	10
C1941	NERO 19 mmx20M	10
C1920	COLORI VARI 19 mmX 10M	10
C1921	COLORI VARI 19 mmx20M	10

Nastro isolante in fibra nero



CODICE	DESCRIZIONE	Q.TÀ
YT-81500	NASTRO PER CABLAGGI 19 mmx15M	10

Nastro teflon



CODICE	DESCRIZIONE	Q.TÀ
C1942	SPESSORE 0,1 mm 12 mmx10M	10
C1944	SPESSORE 0,2 mm 19 mmx15M	10

Nastro adesivo per imballo



CODICE	DESCRIZIONE	Q.TÀ
C1924	AVANA 48 mmx40M	10
C1925	AVANA 48 mmx66M	10
C1926	TRASPARENTE 48 mmx40M	10
C1927	TRASPARENTE 48 mmx66M	10

Nastro americano per imballo



CODICE	DESCRIZIONE	Q.TÀ
C1946	48 mmx9M	10
C1947	48 mmx23M	10
C1948	48 mmx45M	10

Nastro in alluminio



CODICE	DESCRIZIONE	Q.TÀ
TO-75140	48 mm X10M	10
TO-75141	48 mmx50M	10

Nastro carta



CODICE	DESCRIZIONE	Q.TÀ
C1950	30 mmx25M	10
C1951	38 mmx25M	10
C1952	48 mmx25M	10
C1953	30 mmx50M	10
C1954	38 mmx50M	10
C1955	48 mmx50M	10

Nastro biadesivo



CODICE	DESCRIZIONE	Q.TÀ
TO-75260	50 mmx5M	12
TO-75261	50 mmx10M	12
TO-75262	50 mmx25M	12

Film estensibile



CODICE	DESCRIZIONE	Q.TÀ
C1929	2,5KG TRASPARENTE	4
C1930	2,5KG NERO	4

Tira nastro



CODICE	DESCRIZIONE	Q.TÀ
BK8099	PER NASTRO 50 mmx100MT	24

Nastro segnaletico giallo e nero



CODICE	DESCRIZIONE	Q.TÀ
C1945	100MT	10

Nastro segnaletico rosa e bianco



CODICE	DESCRIZIONE	Q.TÀ
C1928	100MT	10

Cinghia di ancoraggio ad uncino con cricchetto 1t



EN12195-2:2000

1T

CODICE	DESCRIZIONE	Q.TÀ
C4912	PORTATA 1T LUNGHEZZA 2MT	6
C4914	PORTATA 1T LUNGHEZZA 4MT	6
C4916	PORTATA 1T LUNGHEZZA 6MT	6
C4918	PORTATA 1T LUNGHEZZA 8MT	6

Cinghia di ancoraggio ad uncino con cricchetto 2t



EN12195-2:2000

2T

CODICE	DESCRIZIONE	Q.TÀ
C4902	PORTATA 2T LUNGHEZZA 2MT	6
C4904	PORTATA 2T LUNGHEZZA 4MT	6
C4906	PORTATA 2T LUNGHEZZA 6MT	6
C4908	PORTATA 2T LUNGHEZZA 8MT	6

Cinghia di ancoraggio ad uncino con cricchetto 5t



EN12195-2:2000

5T

CODICE	DESCRIZIONE	Q.TÀ
C5004	PORTATA 5T LUNGHEZZA 4MT	6
C5006	PORTATA 5T LUNGHEZZA 6MT	6
C5008	PORTATA 5T LUNGHEZZA 8MT	6
C5010	PORTATA 5T LUNGHEZZA 10MT	6
C5012	PORTATA 5T LUNGHEZZA 12MT	6
C5014	PORTATA 5T LUNGHEZZA 14MT	6
C5016	PORTATA 5T LUNGHEZZA 16MT	6

Cinghia di ancoraggio ad uncino con cricchetto 5t con protezioni per rimorchiatore



5T

CODICE	DESCRIZIONE	Q.TÀ
CP003	PORTATA 5T LUNGHEZZA 3MT	6

Gancio per altalena



CODICE	DESCRIZIONE	Q.TÀ
A218102	PALO TONDO Ø100 mm	10
A207519	PALO TONDO Ø120 mm	10
A16748	CON BARRA FILETTATA LUNGHEZZA 200 mm	10

Telo copritutto



CODICE	DESCRIZIONE	Q.TÀ
TO-09463	TELO COPRITUTTO 4X5 15UM	10

Sacchi per rifiuti giardino



CODICE	DESCRIZIONE	Q.TÀ
TO-09481	120L 60µm 10 PEZZI	10

Sacchi per rifiuti



CODICE	DESCRIZIONE	Q.TÀ
TO-10010	GIALLO- PLASTICA 120L 40µm	10
TO-10012	VERDE ACQUA- VETRO 120L 40µm	10
TO-10013	MARRONE- UMIDO 120L 40µm	10
TO-10014	ROSSO- METALLO 120L 40µm	10
TO-10015	NERO- INDIFFERENZIATA 120L 40µm	10

Tubo aria compressa



CODICE	DESCRIZIONE	Q.TÀ
C5040	Ø 8X5 mm LUNGHEZZA 5MT	6
C5041	Ø 8X5 mm LUNGHEZZA 10MT	6
C5042	Ø 8X5 mm LUNGHEZZA 15MT	6
C5046	Ø 12X8 mm LUNGHEZZA 5MT	6
C5047	Ø 12X8 mm LUNGHEZZA 10MT	6
C5048	Ø 12X8 mm LUNGHEZZA 15MT	6
C5049	Ø 12X8 mm LUNGHEZZA 20MT	6

Raccordo maschio e femmina



CODICE	DESCRIZIONE	Q.TÀ
C5080	RACCORDO 8X5 MASCHIO	6
C5081	RACCORDO 8X5 FE mmINA	6
C5082	RACCORDO 12X8 MASCHIO	6
C5083	RACCORDO 12X8 FE mmINA	6

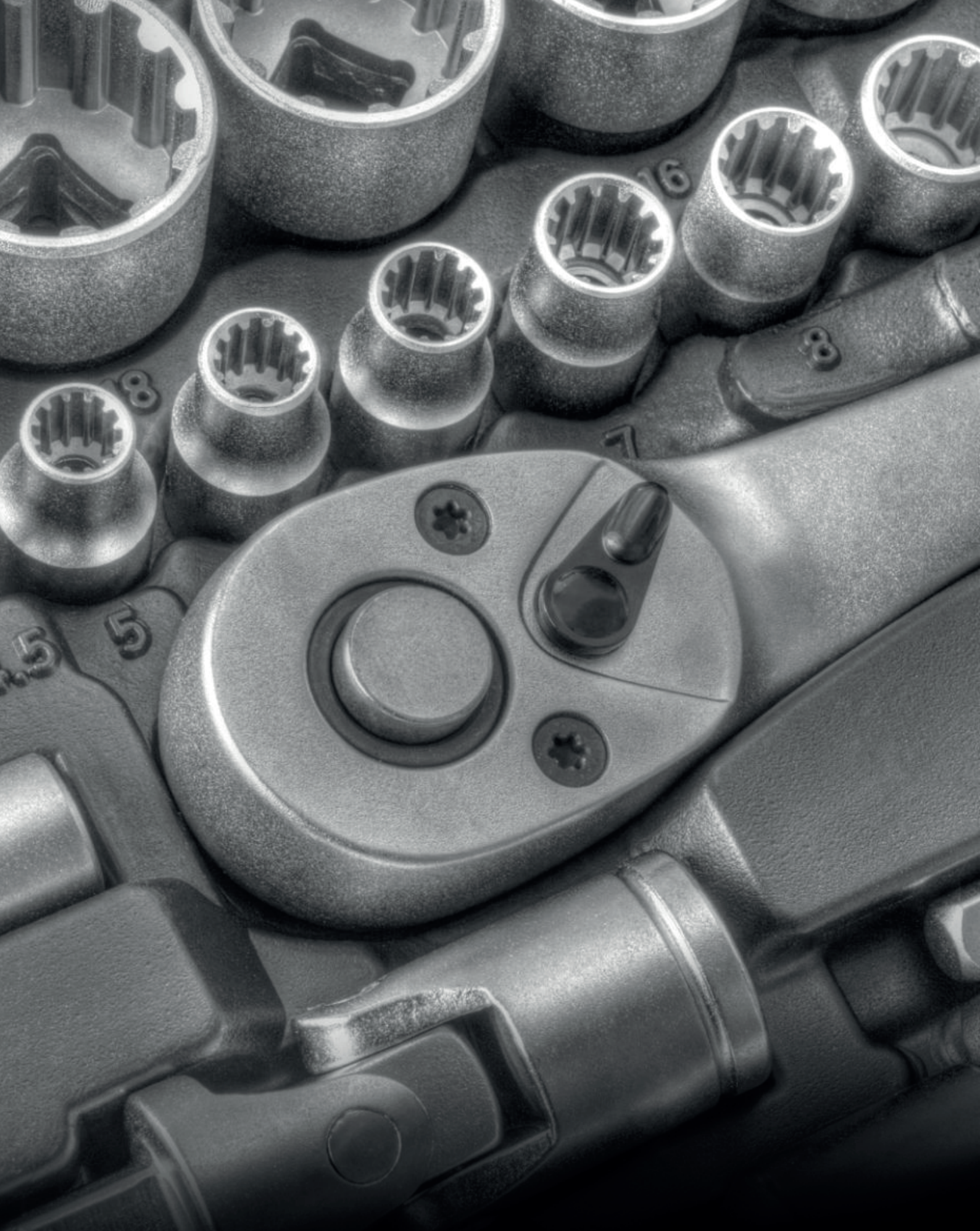

UTENSILERIA

Cassetta portautensili antirottura



CODICE	DESCRIZIONE	Q.TÀ
C1390	16" 390X400X110 mm	6
C1392	24" 390X600X110 mm	6

Cassa portautensili antirottura



METALLO

CODICE	DESCRIZIONE	Q.TÀ
C1260	3 ELEMENTI 430X200X160 mm	6
C1264	7 ELEMENTI 230X200X250 mm	6

Rotolo gomma magnetica isotropica



CODICE	DESCRIZIONE	Q.TÀ
M2103600	25 mmxL25 MT	25
M2103601	25 mmxL25 MT	25
M2103602	25 mmxL25 MT	25
M2103603	25 mmxL25 MT	25

Barra portautensili magnetico

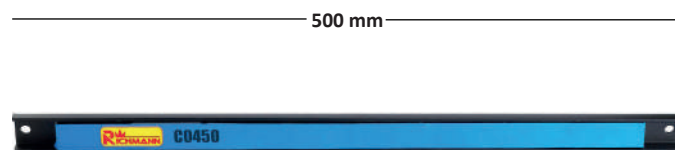

CODICE	DESCRIZIONE	Q.TÀ
C0450	500 mm	10

Vassoio portautensili magnetico

Circolare



ZINCATO

CODICE	DESCRIZIONE	Q.TÀ
C0452	Ø150 mm	6

Vassoio portautensili magnetico

Rettangolare



ZINCATO

CODICE	DESCRIZIONE	Q.TÀ
C0453	150X350 mm	6

**Raccogliatore allungabile
A 600 mm magnetico**

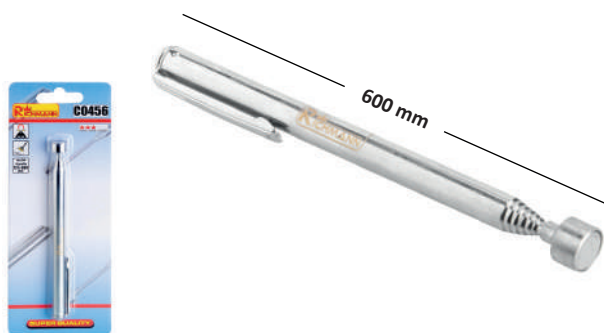

CODICE	DESCRIZIONE	Q.TÀ
C0455	1,5 KG	25
C0456	2,5 KG	25
C0457	4 KG	25

Raccogliatore con ganci 600 mm

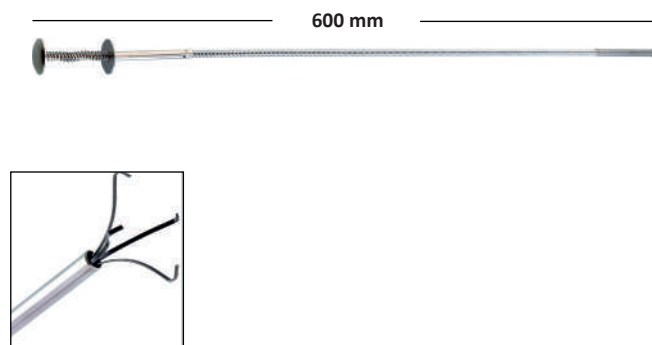

CODICE	DESCRIZIONE	Q.TÀ
C0485	RACCOGLITORE CON GANCI 600 mm	10

Raccogliatore magnetico con ganci

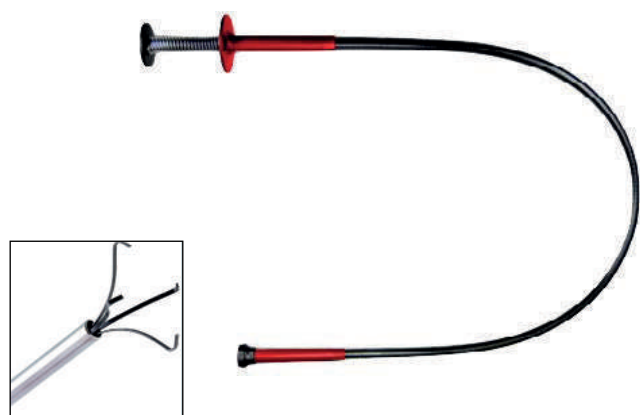

CODICE	DESCRIZIONE	Q.TÀ
1082459	GANCI DA 23 mm	4

**Set raccogliatore allungabile magnetico
con specchio e con magneti**



CODICE	DESCRIZIONE	Q.TÀ
C0462	SET RACCOGLIERE ALLUNGABILE MAGNETICO	10

Supporto magnetico a 3 angoli



45° 90° 135°

CODICE	DESCRIZIONE	Q.TÀ
C0465	SENZA FORO CENTRALE 12,5 KG	25
C0466	CON FORO CENTRALE 25 KG	25
C0467	CON FORO CENTRALE 37,5 KG	25

Supporto magnetico a 6 angoli

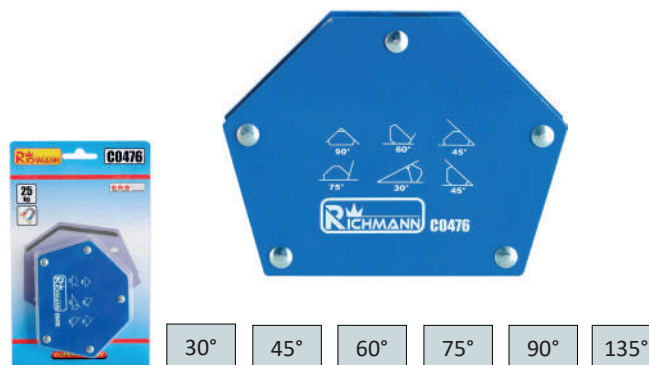

30° 45° 60° 75° 90° 135°

CODICE	DESCRIZIONE	Q.TÀ
C0475	SENZA FORO CENTRALE 12,5 KG	25
C0476	CON FORO CENTRALE 25 KG	25
C0477	CON FORO CENTRALE 37,5 KG	25

Portainseri magnetico flessibile



CODICE	DESCRIZIONE	Q.TÀ
108143040 GR	225 mm	10

Portainseri magnetico con anello

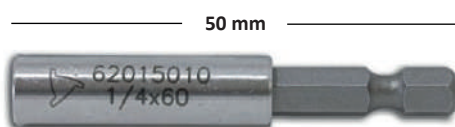

CODICE	DESCRIZIONE	Q.TÀ
62015005	ATTACCO 1/4 L=50 mm	12
62015010	ATTACCO 1/4 L=60 mm	12
62015015	ATTACCO 1/4 L=75 mm	12
62015020	ATTACCO 1/4 L=100 mm	6
62015030	ATTACCO 1/4 L=150 mm	4
62015035	ATTACCO 1/4 L=200 mm	4
62015040	ATTACCO 1/4 L=250 mm	4

Portainseri magnetico

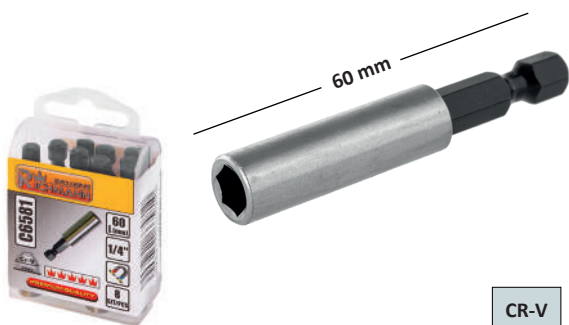

CR-V 1/4"

CODICE	DESCRIZIONE	Q.TÀ
C6581	60 mm	25
C6582	150 mm	25

Portainseri magnetico snodabile



CODICE	DESCRIZIONE	Q.TÀ
1081430GR 30	PORTAINSERI MAGNETICO SNODABILE	25

Chiave magnetica testa ad esagono



1/4"

CODICE	DESCRIZIONE	Q.TÀ
C2449	L.45 ATT. 1/4" PER ESAGONO- DA 7 mm	5
C2450	L.45 ATT. 1/4" PER ESAGONO- DA 8 mm	5
C2451	L.45 ATT. 1/4" PER ESAGONO- DA 10 mm	5
C2452	L.45 ATT. 1/4" PER ESAGONO- DA 13 mm	5
67143070-17	L.45 ATT. 1/4" PER ESAGONO- DA 17 mm	5

Portainseri magnetico automatico

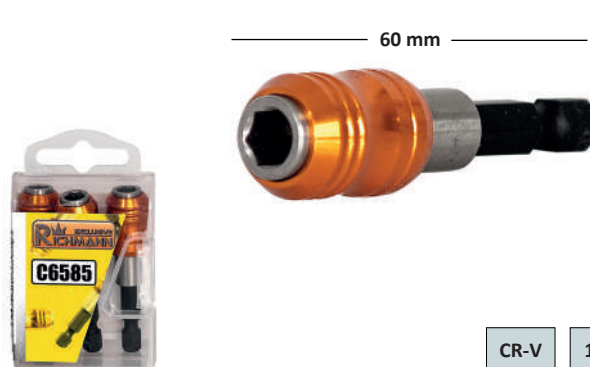

CR-V 1/4"

CODICE	DESCRIZIONE	Q.TÀ
C6585	60 mm	3

Adattatore L50 mm con attacco 1/4"

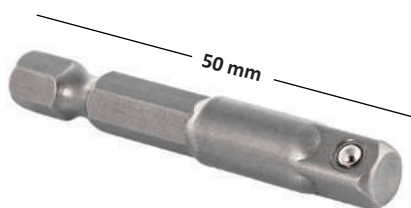

1/4"

CODICE	DESCRIZIONE	Q.TÀ
C4417	1/4" 50 mm CON ATTACCO 1/4"	10
C4418	3/8" 50 mm CON ATTACCO 1/4"	5
C4419	1/2" 50 mm CON ATTACCO 1/4"	4

Giravite per inserti da 1/4"



CODICE	DESCRIZIONE	Q.TÀ
CH1717-3-610014	1/4"	4

Set inserti



INSERTI
L25 mm
PORTA
INSERTI
L60 mm

CODICE	DESCRIZIONE	Q.TÀ
C6590	SET 17 INSERTI PH E PZ 1-2-2-3 L. 25 mm+ TX 15-20-25-30-40 + TAGLIA 4-5-7 + PORTA INSERTI MAGNETICO	10

Set inserti



INSERTI
L25 mm
PORTA
INSERTI
L60 mm

CODICE	DESCRIZIONE	Q.TÀ
C6591	SET 17 INSERTI PH E PZ 1-2-2-3 L. 25 mm+ TX 15-20-25-30-40 + TAGLIA 4-5-7 + PORTA INSERTI MAGNETICO AUTOMATICO	10

Inserto zigrinato PH



25 mm



ACR ACCIAIO S2

CODICE	DESCRIZIONE	Q.TÀ
C6520	PH 1x25 mm	25
C6521	PH 2x25 mm	25
C6522	PH 3x25 mm	25

Inserto zigrinato PZ



25 mm



ACR ACCIAIO S2

CODICE	DESCRIZIONE	Q.TÀ
C6525	PZ 1x25 mm	25
C6526	PZ 2x25 mm	25
C6527	PZ 3x25 mm	25

Inserto esagonale SW



25 mm

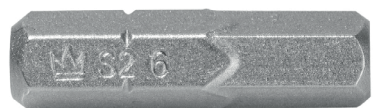

1/4" HRC 58-62 ACCIAIO S2

CODICE	DESCRIZIONE	Q.TÀ
C6560	SW 4x25 mm	25
C6561	SW 5x25 mm	25
C6562	SW 6x25 mm	25
C6563	SW 7x25 mm	25
C6564	SW 8x25 mm	25

Inserto TORX



25 mm



1/4" HRC 58-62 ACCIAIO S2

CODICE	DESCRIZIONE	Q.TÀ
C6570	10x25 mm	25
C6571	15x25 mm	25
C6571	20x25 mm	25
C6573	25x25 mm	25
C6574	27x25 mm	25
C6575	30x25 mm	25
C6576	35x25 mm	25
C6577	40x25 mm	25

Inserto lungo PH 50 mm



50 mm



ACR ACCIAIO S2

CODICE	DESCRIZIONE	Q.TÀ
C6530	PH 1x50 mm	15
C6531	PH 2x50 mm	15
C6532	PH 3x50 mm	15

Inserto lungo PZ 50 mm



50 mm



ACR ACCIAIO S2

CODICE	DESCRIZIONE	Q.TÀ
C6535	PZ 1x50 mm	15
C6536	PZ 2x50 mm	15
C6537	PZ 3x50 mm	15

Inserto lungo TX 50 mm



1/4" HRC 58-62 ACCIAIO S2

CODICE	DESCRIZIONE	Q.TÀ
C6592	INSERTO LUNGO TX 10x50 mm	15
C6593	INSERTO LUNGO TX 15x50 mm	15
C6594	INSERTO LUNGO TX 20x50 mm	15
C6595	INSERTO LUNGO TX 25x50 mm	15
C6596	INSERTO LUNGO TX 27x50 mm	15
C6597	INSERTO LUNGO TX 30x50 mm	15
C6598	INSERTO LUNGO TX 35x50 mm	15
C6599	INSERTO LUNGO TX 40x50 mm	15

Inserto extra lungo 100 mm



ACR ACCIAIO S2

CODICE	DESCRIZIONE	Q.TÀ
C6541	INSERTO EXTRA- LUNGO PH 2x100 mm	10
C6544	INSERTO EXTRA- LUNGO PZ 2x100 mm	10

Inserto extra lungo 150 mm



1/4" ACR ACCIAIO S2

CODICE	DESCRIZIONE	Q.TÀ
C6551	INSERTO EXTRA- LUNGO PH 2x150 mm	10
C6554	INSERTO EXTRA- LUNGO PZ 2x150 mm	10

Inserto extra lungo 200 mm



1/4" ACR ACCIAIO S2

CODICE	DESCRIZIONE	Q.TÀ
C6556	INSERTO EXTRA- LUNGO PH 2x200 mm	5
C6557	INSERTO EXTRA- LUNGO PZ 2x200 mm	5

Inserto extra lungo 250 mm



1/4" ACR ACCIAIO S2

CODICE	DESCRIZIONE	Q.TÀ
C6558	INSERTO EXTRA- LUNGO PH 2x250 mm	5
C6559	INSERTO EXTRA- LUNGO PZ 2x250 mm	5

Inserto per cartongessista PH-2

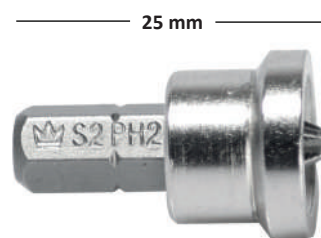

1/4" ACR ACCIAIO S2

CODICE	DESCRIZIONE	Q.TÀ
C6580	INSERTO PER CARTONGESSISTA PH-2	10

Inserto TORX attacco 10 mm



ACCIAIO S2

CODICE	DESCRIZIONE	Q.TÀ
C3208	45X30 mm	5
C3209	50X30 mm	5
C3210	55X30 mm	5
C3211	60X30 mm	5
C3212	70X30 mm	5

Adattatore per inserti attacco 10 mm



ACCIAIO CR-V

CODICE	DESCRIZIONE	Q.TÀ
C4416	ATTACCO 10 mm DA 1/2"	5
C4415	ATTACCO 10 mm DA 3/8"	5
C4410	ATTACCO 1/4" DA 1/2"	5

Inserto attacco + magnete PH

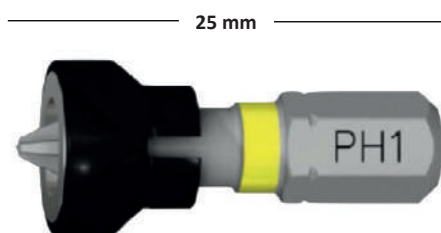

1/4"

CODICE	DESCRIZIONE	Q.TÀ
IMB-PH1X25	PH 1x25 mm	20
IMB-PH2X25	PH 2x25 mm	20
IMB-PH3X25	PH 3x25 mm	20

Inserto attacco + magnete PH 50 mm

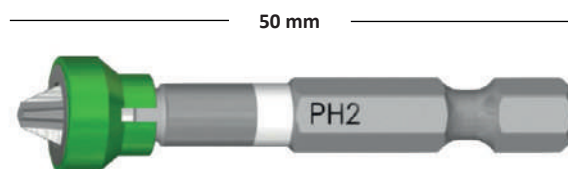

1/4"

CODICE	DESCRIZIONE	Q.TÀ
IMB-PH1X50	PH 1x50 mm	10
IMB-PH2X50	PH 2x50 mm	10
IMB-PH3X50	PH 3x50 mm	10

Inserto attacco + magnete PZ

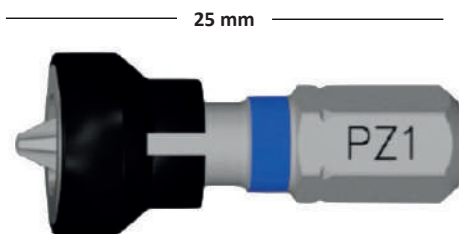

1/4"

CODICE	DESCRIZIONE	Q.TÀ
IMB-PZ1X25	PZ 1x25 mm	20
IMB-PZ2X25	PZ 2x25 mm	20
IMB-PZ3X25	PZ 3x25 mm	20

Inserto attacco + magnete PZ 50 mm

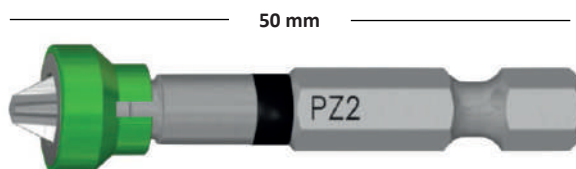

1/4"

CODICE	DESCRIZIONE	Q.TÀ
IMB-PZ1X50	PZ 1x50 mm	10
IMB-PZ2X50	PZ 2x50 mm	10
IMB-PZ3X50	PZ 3x50 mm	10

Inserto attacco + magnete TX

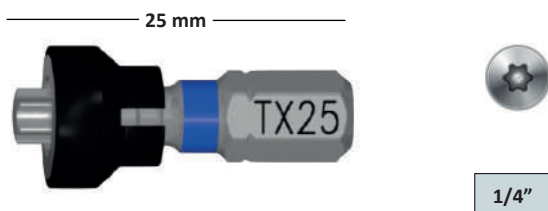

CODICE	DESCRIZIONE	Q.TÀ
IMB-TX10X25	TX 10x25 mm	20
IMB-TX15X25	TX 15x25 mm	20
IMB-TX20X25	TX 20x25 mm	20
IMB-TX25X25	TX 25x25 mm	20
IMB-TX27X25	TX 27x25 mm	20
IMB-TX30X25	TX 30x25 mm	20
IMB-TX40X25	TX 40x25 mm	20

Inserto attacco + magnete TX 50 mm

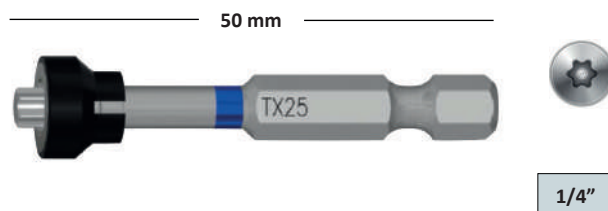

CODICE	DESCRIZIONE	Q.TÀ
IMB-TX10X50	TX 10x50 mm	20
IMB-TX15X50	TX 15x50 mm	20
IMB-TX20X50	TX 20x50 mm	20
IMB-TX25X50	TX 25x50 mm	20
IMB-TX27X50	TX 27x50 mm	20
IMB-TX30X50	TX 30x50 mm	20
IMB-TX40X50	TX 40x50 mm	20

Inserto torsion blu PH

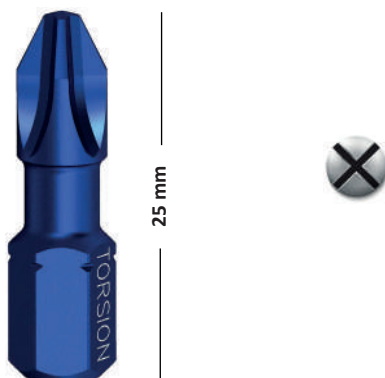

CODICE	DESCRIZIONE	Q.TÀ
61058005050-1	PH 1x25 mm	50
61058010050-2	PH 2x25 mm	50
61058015050-3	PH 3x25 mm	50

Inserto torsion blu PH 50 mm



CODICE	DESCRIZIONE	Q.TÀ
61059005-1	PH 1x50 mm	10
61059010-2	PH 2x50 mm	10
61059015-3	PH 3x50 mm	10

Inserto torsion blu pz

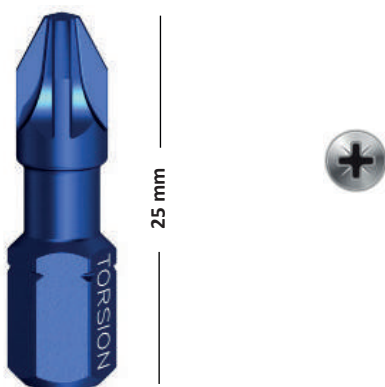

CODICE	DESCRIZIONE	Q.TÀ
61083005050-1	PZ 1x25 mm	50
61083010050-2	PZ 2x25 mm	50
61083015050-3	PZ 3x25 mm	50

Inserto torsion blu pz 50 mm

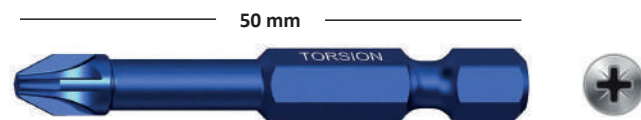

CODICE	DESCRIZIONE	Q.TÀ
61084005-1	PZ 1x50 mm	10
61084010-2	PZ 2x50 mm	10
61084015-3	PZ 3x50 mm	10

Inserto torsion blu TX



CODICE	DESCRIZIONE	Q.TÀ
61103005050-T10	TX 10x25 mm	50
61103010050-T15	TX 15x25 mm	50
61103015050-T20	TX 20x25 mm	50
61103020050-T25	TX 25x25 mm	50
61103025050-T27	TX 27x25 mm	50
61103030050-T30	TX 30x25 mm	50
61103035050-T40	TX 40x25 mm	50

Inserto torsion blu TX lungo



CODICE	DESCRIZIONE	Q.TÀ
61104005-T10	TX 10x50 mm	10
61104009-T15	TX 15x50 mm	10
61104010-T20	TX 20x50 mm	10
61104020-T25	TX 25x50 mm	10
61104025-T27	TX 27x50 mm	10
61104030-T30	TX 30x50 mm	10
61104035-T40	TX 40x50 mm	10



Chiave combinata lucida



ACCIAIO CR-V

CODICE	DESCRIZIONE	Q.TÀ
C6306	DA 6	12
C6307	DA 7	12
C6308	DA 8	12
C6309	DA 9	12
C6310	DA 10	12
C6311	DA 11	12
C6312	DA 12	12
C6313	DA 13	12
C6314	DA 14	12
C6315	DA 15	6
C6316	DA 16	6
C6317	DA 17	6
C6318	DA 18	6
C6319	DA 20	6
C6320	DA 21	6
C6321	DA 22	6
C6322	DA 23	6
C6323	DA 24	6
C6324	DA 25	6
C6325	DA 26	6
C6326	DA 27	6
C6327	DA 28	6
C6328	DA 29	6
C6329	DA 30	6
C6330	DA 31	6
C6332	DA 32	6

Chiave poligonale lucida



ACCIAIO CR-V

CODICE	DESCRIZIONE	Q.TÀ
C6840	DA 6- 7	8
C6841	DA 8- 9	8
C6842	DA 10- 11	8
C6843	DA 12- 13	8
C6844	DA 14- 15	8
C6845	DA 16- 17	8
C6846	DA 18- 19	8
C6847	DA 20- 22	8
C6848	DA 21- 23	8
C6849	DA 24- 27	8
C6850	DA 25- 28	8
C6851	DA 30- 32	8

Chiave combinata cricchetto piegabile



ACCIAIO CR-V

CODICE	DESCRIZIONE	Q.TÀ
C7438	DA 8	5
C7440	DA 10	5
C7442	DA 12	5
C7443	DA 13	5
C7444	DA 14	5
C7445	DA 15	5
C7446	DA 16	5
C7447	DA 17	5
C7448	DA 18	5
C7449	DA 19	5

Set 5pz chiave combinata cricchetto



CHIAVE (mm)
8-10-13-17-19

ACCIAIO CR-V

CODICE	DESCRIZIONE	Q.TÀ
C7401	SET 5PZ CHIAVE COMBINATA CRICCHETTO 8/19	5

Set chiave combinata lucida



CHIAVE (mm)
6-7-8-9-10-11-12-13-14-17-19-22

CODICE	DESCRIZIONE	Q.TÀ
C6343	SET CHIAVE COMBINATA 12PZ DALLA 6 ALLA 22	6

Set 12PZ 6-32 confezione in tela



CHIAVE (mm)
6-8-10-13-15-17-19-22-24-27-30-32

CODICE	DESCRIZIONE	Q.TÀ
C6344	12PZ CHIAVE COMBINATA 6-32 CONFEZIONE TELA	4

Set 24PZ 6-32
Confezione in tela



CHIAVE (mm)
6-7-8-9-10-11-12-13-14-15-16-17-18-19-20-21-22-23-24-26-27-28-30-32

ACCIAIO
CR-V

CODICE	DESCRIZIONE	Q.TÀ
C6345	SET CHIAVE COMBINATA 24PZ 6-32 CONF TELA	3

Set 12PZ chiave combi forche 6-32
Confezione in tela



CHIAVE (mm)
6X7-8X9-10X11-12X13-14X15-16X17-18X19-20X22-21X23-24X27-25X28-30X32

ACCIAIO
CR-V

CODICE	DESCRIZIONE	Q.TÀ
C6033	12PZ CHIAVE COMBINATA FORCHE 6-32 CONFEZIONE TELA	6

Rimuovi filtro olio nastro di cuoio



CODICE	DESCRIZIONE	Q.TÀ
CB2301	55-110 mm 9'	6
CB2302	55-150 mm 12'	6

Rimuovi filtro olio a catena



CODICE	DESCRIZIONE	Q.TÀ
CB2303	55-110 mm 9'	6
CB2304	55-150 mm 12'	6

Chiave a croce per ruote



ACCIAIO CR-V

CODICE	DESCRIZIONE	Q.TÀ
C6783	17-19-21X1/2"	5

Serie chiave esagonale 1,5 - 10 Extra lunga



ACCIAIO S2

ESAGONALE 1,5-2-2,5-3-4-5-6-8-10

CODICE	DESCRIZIONE	Q.TÀ
C6601	1,5- 10 mm EXTRA LUNGA	12

Serie chiave TORX 10 - 50 Extra lunga



ACCIAIO S2

TORX 10-15-20-25-27-30-40-45-50

CODICE	DESCRIZIONE	Q.TÀ
C6602	TORX T10- T50 EXTRA LUNGA	12

Chiave a bussola universale



DUREZZA HRC 40 ACCIAIO CRV

CODICE	DESCRIZIONE	Q.TÀ
YT-02400	DIMENSIONI 8-19 mm CON CRICCHETTO	12

Chiavi a brugola pieghevoli 1,5 - 8 mm



CODICE	DESCRIZIONE	Q.TÀ
C6609	1,5 mm-2 mm-2,5 mm-3 mm-4 mm-5 mm-6 mm-8 mm	8

Chiave a brugola con manico a "T"



CODICE	DESCRIZIONE	Q.TÀ
C6680	1,5 mm	8
C6681	2 mm	8
C6682	2,5 mm	8
C6683	3 mm	8
C6684	4 mm	8
C6685	5 mm	8
C6686	6 mm	8
C6687	8 mm	8
C6688	10 mm	9

Chiave a tubo



NEW

ACCIAIO CR-V

CODICE	DESCRIZIONE	CODICE	DESCRIZIONE	Q.TÀ
C6706	6 mm	C6715	15 mm	10
C6707	7 mm	C6716	16 mm	
C6708	8 mm	C6717	17 mm	
C6710	10 mm	C6718	18 mm	
C6711	11 mm	C6719	19 mm	
C6712	12 mm	C6722	22 mm	
C6713	13 mm	C6724	24 mm	
C6714	14 mm	C6727	27 mm	

Set chiavi a tubo



NEW

ACCIAIO CR-V

CODICE	DESCRIZIONE	Q.TÀ
C6740	8 mm	12
	10 mm	
	13 mm	
	17 mm	
	19 mm	

Set di bussole con manico



NEW

ACCIAIO CR-V

CODICE	DESCRIZIONE	Q.TÀ
C4019	BUSSOLE	10
	MANICO	

8-9-10-11-12-13-14-15-16-17-19-21-22-23-24-27-30-32 mm
1/2"

Set di bussole con manico



NEW

ACCIAIO CR-V

CODICE	DESCRIZIONE	Q.TÀ	
C1127	BUSSOLE	10	
	MANICO		
	PUNTE DA 1/4"		
			TORX: T10, T15, T20, T25, T30
			HEX: H3, H4, H5, H6

4-4,5-5-5,5-6-7-8-9-10-11-12-13 mm
1/4"
PH-1, PH2
4-5,5-7

Chiave a bussola TORX attacco 1/4"



1/4"

ACCIAIO
CR-V

CODICE	DESCRIZIONE	Q.TÀ
C1424	1/4" E4	6
C1425	1/4" E5	6
C1426	1/4" E6	6
C1427	1/4" E7	6
C1428	1/4" E8	6

Chiave a bussola TORX attacco 1/2"



1/2"

ACCIAIO
CR-V

CODICE	DESCRIZIONE	Q.TÀ
C1570	1/2" E10	6
C1571	1/2" E11	6
C1572	1/2" E12	6
C1574	1/2" E14	6
C1576	1/2" E16	6
C1578	1/2" E18	6
C1580	1/2" E20	6
C1582	1/2" E22	6
C1584	1/2" E24	6

Chiave bussola da 1/4" lunga 50 mm



1/4"

ACCIAIO
CR-V

CODICE	DESCRIZIONE	Q.TÀ
C4104	1/4" 4 mm	6
C4145	1/4" 4,5 mm	6
C4105	1/4" 5 mm	6
C4155	1/4" 5,5 mm	6
C4106	1/4" 6 mm	6
C4107	1/4" 7 mm	6
C4108	1/4" 8 mm	6
C4109	1/4" 9 mm	6
C4110	1/4" 10 mm	6
C4111	1/4" 11 mm	6
C4112	1/4" 12 mm	6
C4113	1/4" 13 mm LUNGA	6

Chiave bussola da 1/4"



1/4"

ACCIAIO
CR-V

CODICE	DESCRIZIONE	Q.TÀ
C1404	1/4" DA 4	6
C1445	1/4" DA 4,5	6
C1405	1/4" DA 5	6
C1455	1/4" DA 5,5	6
C1406	1/4" DA 6	6
C1407	1/4" DA 7	6
C1408	1/4" DA 8	6
C1409	1/4" DA 9	6
C1410	1/4" DA 10	6
C1411	1/4" DA 11	6
C1412	1/4" DA 12	6
C1413	1/4" DA 13	6

Chiave bussola da 3/4"



3/4"

ACCIAIO
CR-V

CODICE	DESCRIZIONE	Q.TÀ
C1717	3/4" DA 17	6
C1719	3/4" DA 19	6
C1721	3/4" DA 21	6
C1722	3/4" DA 22	6
C1724	3/4" DA 24	6
C1727	3/4" DA 27	6
C1730	3/4" DA 30	6
C1732	3/4" DA 32	6
C1734	3/4" DA 34	6
C1736	3/4" DA 36	6
C1738	3/4" DA 38	6
C1741	3/4" DA 41	4
C1746	3/4" DA 46	4
C1750	3/4" DA 50	5
C1755	3/4" DA 55	4
C1760	3/4" DA 60	4

Chiave bussola da 1/2"



1/2" ACCIAIO CR-V

CODICE	DESCRIZIONE	Q.TÀ
C1508	1/2" DA 8	24
C1509	1/2" DA 9	24
C1510	1/2" DA 10	24
C1511	1/2" DA 11	24
C1512	1/2" DA 12	24
C1513	1/2" DA 13	24
C1514	1/2" DA 14	24
C1515	1/2" DA 15	24
C1516	1/2" DA 16	24
C1517	1/2" DA 17	24
C1518	1/2" DA 18	24
C1519	1/2" DA 19	24
C1521	1/2" DA 21	8
C1522	1/2" DA 22	8
C1524	1/2" DA 24	8
C1527	1/2" DA 27	8
C1530	1/2" DA 30	8
C1532	1/2" DA 32	8

Chiave bussola da 1/2" lunga 80 mm



1/2" ACCIAIO CR-V

CODICE	DESCRIZIONE	Q.TÀ
C5108	1/2" LUNGA DA 8	12
C5109	1/2" LUNGA DA 9	12
C5110	1/2" LUNGA DA 10	12
C5111	1/2" LUNGA DA 11	12
C5112	1/2" LUNGA DA 12	12
C5113	1/2" LUNGA DA 13	12
C5114	1/2" LUNGA DA 14	12
C5115	1/2" LUNGA DA 15	12
C5116	1/2" LUNGA DA 16	12
C5117	1/2" LUNGA DA 17	12
C5118	1/2" LUNGA DA 18	12
C5119	1/2" LUNGA DA 19	12
C5121	1/2" LUNGA DA 21	4
C5122	1/2" LUNGA DA 22	4
C5124	1/2" LUNGA DA 24	4
C5127	1/2" LUNGA DA 27	4
C5130	1/2" LUNGA DA 30	4
C5132	1/2" LUNGA DA 32	4

Set 9pz chiave a bussola TORX attacco 1/2" E10-E24



1/2" ACCIAIO CR-V

CODICE	DESCRIZIONE	Q.TÀ
C4009	SET 9PZ CHIA BUSS TORX ATT. 1/2" E10-E24	6

Set 8pz chiave a bussola TORX attacco 3/8" E6-E16



3/8" ACCIAIO CR-V

CODICE	DESCRIZIONE	Q.TÀ
C3008	SET 8PZ CHIAVE A BUSSOLA TORX ATTACCO 3/8" E6-E16	6

Espositore da banco bussole da 1/2" normali e lunghe 162pz



ACCIAIO CR-V

1/2"

	CORTO		PROFONDO			
	mm	PZ	mm	PZ		
CZ01	C1508	8	5	C5108	8	6
	C1509	9	5	C5109	9	6
	C1510	10	10	C5110	10	6
	C1511	11	5	C5111	11	6
	C1512	12	5	C5112	12	6
	C1513	13	10	C5113	13	6
	C1514	14	5	C5114	14	6
	C1515	15	5	C5115	15	6
	C1516	16	5	C5116	16	6
	C1517	17	10	C5117	17	6
	C1518	18	4	C5118	18	6
	C1519	19	10	C5119	19	6
	C1521	21	4	C5121	21	6
	C1522	22	4	C5122	22	6
	C1524	24	6	C5124	24	6
	C1527	27	3	C5127	27	6
C1530	30	2	C5130	30	6	
C1532	32	2	C5132	32	6	

Set 11pz chiave a bussola attacco 1/4" 4-13 mm



NEW

1/4" ACCIAIO CR-V



CODICE	DESCRIZIONE	Q.TÀ
C1111	SET 9PZ CHIAVE A BUSSOLA 1/4" 4-13 mm	6

Set 10pz chiave a bussola attacco 1/2" 10-24 mm



NEW

1/2" ACCIAIO CR-V



CODICE	DESCRIZIONE	Q.TÀ
C4010	SET 10PZ CHIAVE A BUSSOLA 1/2" 10-24 mm	6

Chiave bussola a impatto 1/2"



1/2" ACCIAIO CR-MO

CODICE	DESCRIZIONE	Q.TÀ
C1800	1/2" DA 8	10
C1802	1/2" DA 10	10
C1803	1/2" DA 11	10
C1804	1/2" DA 12	10
C1805	1/2" DA 13	10
C1806	1/2" DA 14	10
C1807	1/2" DA 15	10
C1808	1/2" DA 16	10
C1809	1/2" DA 17	10
C1810	1/2" DA 18	10
C1811	1/2" DA 19	10
C1812	1/2" DA 20	10
C1813	1/2" DA 21	10
C1814	1/2" DA 22	10
C1815	1/2" DA 23	10
C1816	1/2" DA 24	10
C1817	1/2" DA 25	10
C1818	1/2" DA 26	10
C1819	1/2" DA 27	10
C1820	1/2" DA 28	10
C1821	1/2" DA 29	10
C1822	1/2" DA 30	10
C1823	1/2" DA 32	6

Chiave bussola a impatto 1/2"



1/2" ACCIAIO CR-MO

CODICE	DESCRIZIONE	Q.TÀ
C1835	1/2" DA E10	10
C1836	1/2" DA E12	10
C1837	1/2" DA E14	10
C1838	1/2" DA E16	10
C1839	1/2" DA E18	10
C1840	1/2" DA E20	10
C1841	1/2" DA E22	10
C1842	1/2" DA E24	10

Chiave bussola impact 1/2" Lunga 78 mm



1/2" ACCIAIO CR-MO

CODICE	DESCRIZIONE	Q.TÀ
C2800	1/2" LUNGA DA 8	10
C2802	1/2" LUNGA DA 10	10
C2803	1/2" LUNGA DA 11	10
C2804	1/2" LUNGA DA 12	10
C2805	1/2" LUNGA DA 13	10
C2806	1/2" LUNGA DA 14	10
C2807	1/2" LUNGA DA 15	10
C2808	1/2" LUNGA DA 16	10
C2809	1/2" LUNGA DA 17	10
C2810	1/2" LUNGA DA 18	10
C2811	1/2" LUNGA DA 19	10
C2812	1/2" LUNGA DA 20	10
C2813	1/2" LUNGA DA 21	10
C2814	1/2" LUNGA DA 22	10
C2815	1/2" LUNGA DA 23	10
C2816	1/2" LUNGA DA 24	10
C2817	1/2" LUNGA DA 25	10
C2818	1/2" LUNGA DA 26	10
C2819	1/2" LUNGA DA 27	10
C2820	1/2" LUNGA DA 28	10
C2821	1/2" LUNGA DA 29	10
C2822	1/2" LUNGA DA 30	10
C2823	1/2" LUNGA DA 32	6

Adattatore



ACCIAIO CR-V

1/4" 3/8" 1/2" 3/4" 1"

CODICE	DESCRIZIONE	Q.TÀ
C2075	1/4" LUNGHEZZA 75 mm	10
C2100	1/4" LUNGHEZZA 100 mm	10
C2150	1/4" LUNGHEZZA 150 mm	10
C3100	3/8" LUNGHEZZA 100 mm	10
C3150	3/8" LUNGHEZZA 150 mm	10
C4075	1/2" LUNGHEZZA 75 mm	10
C4125	1/2" LUNGHEZZA 125 mm	10
C4200	1/2" LUNGHEZZA 200 mm	10
C4250	1/2" LUNGHEZZA 250 mm	10
C6100	3/4" LUNGHEZZA 100 mm	10
C6200	3/4" LUNGHEZZA 200 mm	10
C6400	3/4" LUNGHEZZA 400 mm	10
C6201	1" LUNGHEZZA 200 mm	10
C6401	1" LUNGHEZZA 400 mm	10

Chiave per radiatore

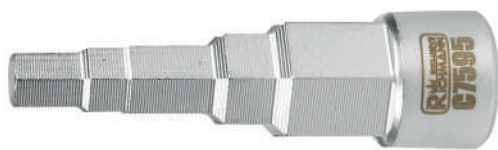

1/2" ACCIAIO CR-V

CODICE	DESCRIZIONE	Q.TÀ
C7595	3/8", 7/16", 1/2", 5/8", 13/16"	6

Macchina cricchetto



ACCIAIO CR-V

1/2"

3/8"

1/4"

CODICE	DESCRIZIONE	Q.TÀ
C8495	1/4" C8453	1
C8496	3/8" C8454	1
C8497	1/2" C8455	1

Macchina cricchetto manico curvo



ACCIAIO CR-V

1/2"

3/8"

1/4"

CODICE	DESCRIZIONE	Q.TÀ
C8489	1/4" C8429	1
C8490	3/8" C8439	1
C8491	1/2" C8449	1

Cricchetto



1/4" 3/8" 1/2" ACCIAIO CR-V

CODICE	DESCRIZIONE	Q.TÀ
C8453	1/4"	6
C8454	3/8"	6
C8455	1/2"	6

Adattatore



ACCIAIO CR-V

CODICE	DESCRIZIONE	Q.TÀ
C4400	1" ESTERNO M: 3/4"	10
C4401	3/4" ESTERNO M: 1"	20
C4402	3/4" ESTERNO M: 1/2"	10
C4403	1/2" ESTERNO M: 3/4"	10
C4404	1/2" ESTERNO M: 3/8"	25
C4405	3/8" ESTERNO M: 1/2"	10
C4406	3/8" ESTERNO M: 1/4"	12
C4407	1/2" ESTERNO M: 1/4"	20

Giunto cardanico



ACCIAIO CR-V

CODICE	DESCRIZIONE	Q.TÀ
C4425	1/2"	10
C4423	1/4"	10

Cricchetto manico curvo



3/8" 1/4" 1/2" ACCIAIO CR-V

CODICE	DESCRIZIONE	Q.TÀ
C8429	1/4"	6
C8439	3/8"	6
C8449	1/2"	6

Serie 43 PZ bussole 1/4" + inserti + Accessori



ACCIAIO S2

ACCIAIO CR-V

1/4"

CODICE	DESCRIZIONE	Q.TÀ	
C1143	SERIE 43 PEZZI BUSSOLE, INSERTI E ACCESSORI	2	
	MANICO 1/4"		
	BARRE DI ESTENSIONE 1/4" 50, 150 mm		
	ESTENSIONE FLESSIBILE 1/4"		
	GIUNTO CARDANICO 1/4"		
	PRESE 1/4" 4; 4,5; 5; 5,5; 6; 7; 8; 9; 10; 11; 12; 13; 14 mm		
	PUNTE IN ACCIAIO S2 1/4"		PIATTE: 4; 5,5; 6,5
			PH1, PH2, PH3
			PZ1, PZ2, PZ3
			HEX: H3, H4, H6, H8 TORX: T8, T10, T15, T20, T25, T27, T30, T40
ADATTATORE 3 STEP 3/8x1/4			

Serie 25 PZ bussole 1/2" + inserti + Accessori



1/2"

ACCIAIO CR-V

CODICE	DESCRIZIONE	Q.TÀ
C4525	SERIE 25 PEZZI BUSSOLE, INSERTI E ACCESSORI	2
	BARRE DI ESTENSIONE 1/2" 125, 250 mm	
	MANOPOLA 1/2"	
	GIUNTO CARDANICO 1/2"	
	PRESE 1/2" 10, 11, 12, 13, 14, 15, 16, 17, 18, 19, 20, 21, 22, 23, 24, 27, 30, 32 mm	
	PRESE PER CANDELE 16, 21 mm	

Serie 94 PZ bussole 1/4" + 1/2" + inserti + accessori



CODICE	DESCRIZIONE	Q.TÀ	
C4094	PRESE CORTE 1/2" 10, 11, 12, 13, 14, 15, 16, 17, 18, 19, 20, 21, 22, 24, 27, 30, 32 mm	2	
	PRESE LUNGHE 1/2" 77 mm 14, 15, 17, 19, 22 mm		
	PRESE PER CANDELE 16, 21 mm		
	MANICO A CRICCHETTO 1/2"		
	CACCIAVITE 1/4"		
	BARRA DI ESTENSIONE 1/2" 125, 250 mm		
	ADATTATORE 1/2"x3/8"		
	GIUNTO CARDANICO 1/2"		
	PRESE CORTE 1/4" 4; 4,5; 5; 5,5; 6; 7; 8; 9; 10; 11; 12; 13; 14 mm		
	PUNTE 1/4"		PIATTE: 4; 5,5; 7
			PH1, PH2
			PZ1, PZ2
			HEX: H3, H4, H5, H6 TORX: T8, T10, T15, T20, T25, T27, T30, T40
	MANICO CRICCHETTO 1/4"		
	MANICO GUIDA 1/4"		
	BARRE DI ESTENSIONE 50, 100 mm		
	MANOPOLA 1/4"		
	PUNTE 5/16" 30 mm		PIATTE: 8, 10, 12 mm
PH3, PH4			
PZ3, PZ4			
HEX: H7, H8, H10, H12, H14 T40, T45, T50, T55			
ADATTATORE 1/2"x5/16"			



ACCIAIO S2

ACCIAIO CR-V

5/16"

1/2"

1/4"



Chiave dinamometrica certificata



ACCIAIO
CR-V

3/8"

1/2"

1/4"



CODICE	DESCRIZIONE	Q.TÀ
C8209	1/4" DA 5- 25 NM	1
C8210	1/2" DA 42- 210 NM	1
C8211	1/2" DA 70- 350 NM	1

Pinza



ACCIAIO
CR-V

CODICE	DESCRIZIONE	Q.TÀ
C7060	LUNGHEZZA 160 mm	6
C7061	LUNGHEZZA 180 mm	6
C7062	LUNGHEZZA 200 mm	6

Tronchese taglio diagonale



ACCIAIO
CR-V

CODICE	DESCRIZIONE	Q.TÀ
C7065	LUNGHEZZA 160 mm	6
C7066	LUNGHEZZA 180 mm	6
C7070	LUNGHEZZA 200 mm	6

Tagliacavi



L=200
mm ACCIAIO
CR-V

CODICE	DESCRIZIONE	Q.TÀ
C7071	LUNGHEZZA 200 mm	6

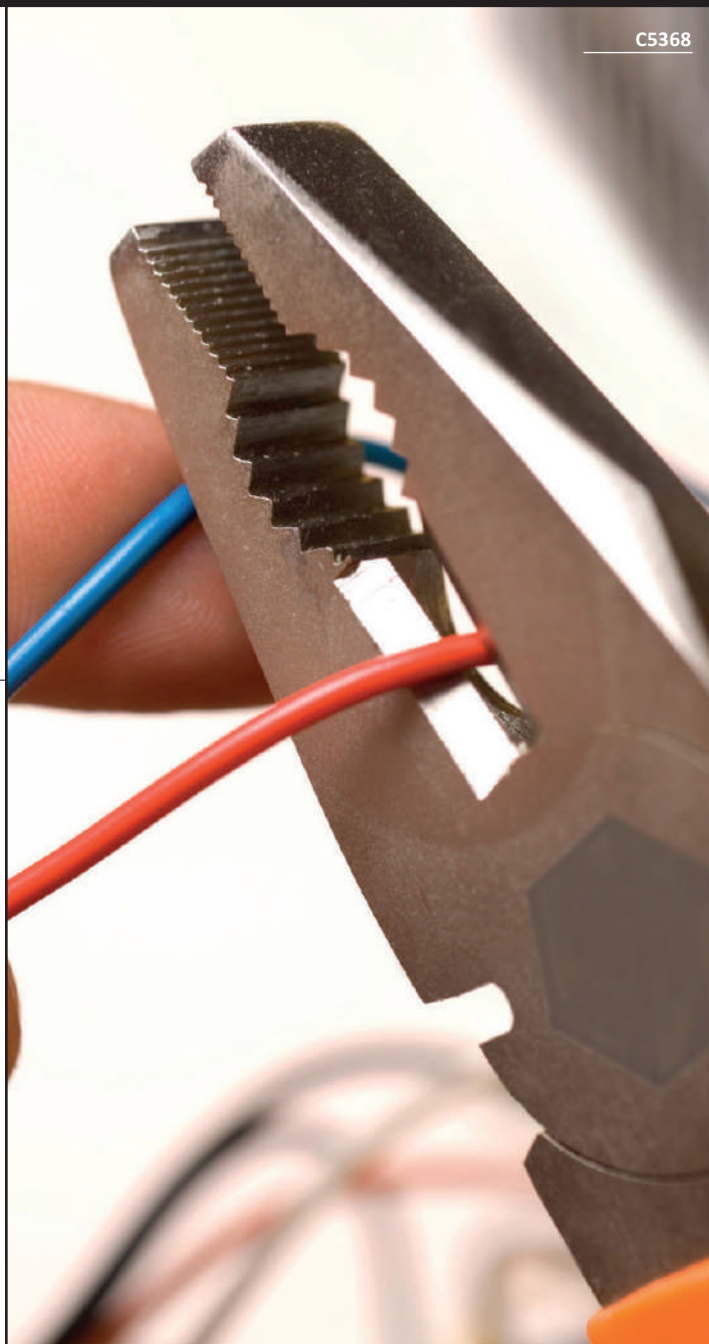

C5368

Tronchese taglio frontale



L=200 mm ACCIAIO CR-V

CODICE	DESCRIZIONE	Q.TÀ
C7057	LUNGHEZZA 200 mm	6

Tronchese taglio frontale



L=275 mm ACCIAIO CR-V

CODICE	DESCRIZIONE	Q.TÀ
C7056	LUNGHEZZA 275 mm	6

Pinza a becco dritto fine



ACCIAIO CR-V

CODICE	DESCRIZIONE	Q.TÀ
C7063	LUNGHEZZA 160 mm	6
C7064	LUNGHEZZA 200 mm	6

Pinza a becco curvo fine



ACCIAIO CR-V

CODICE	DESCRIZIONE	Q.TÀ
C7068	LUNGHEZZA 160 mm	6
C7069	LUNGHEZZA 200 mm	6

Pinza spelacavi



L=160 mm ACCIAIO CR-V

CODICE	DESCRIZIONE	Q.TÀ
C7067	LUNGHEZZA 160 mm	6

Pinza pappagallo



L=250 mm ACCIAIO CR-V

CODICE	DESCRIZIONE	Q.TÀ
C7072	LUNGHEZZA 250 mm	6

Pinza isolata 1000V



ACCIAIO
CR-V

CODICE	DESCRIZIONE	Q.TÀ
C7045	LUNGHEZZA 160 mm	6
C7046	LUNGHEZZA 180 mm	6
C7047	LUNGHEZZA 200 mm	6

Tronchese isolato 1000V



ACCIAIO
CR-V

CODICE	DESCRIZIONE	Q.TÀ
C7048	LUNGHEZZA 160 mm	6
C7049	LUNGHEZZA 180 mm	6

Pinza spelacavi automatica



L=205
mm ACCIAIO
SK5

CODICE	DESCRIZIONE	Q.TÀ
C7180	LUNGHEZZA 205 mm	10

Pinza giratubi svedese



ACCIAIO
CR-V

CODICE	DESCRIZIONE	Q.TÀ
C7579	LUNGHEZZA 230 mm - 0,5"	1
C7580	LUNGHEZZA 320 mm - 1"	1
C7581	LUNGHEZZA 420 mm - 1,5"	1
C7582	LUNGHEZZA 550 mm - 2"	1
C7583	LUNGHEZZA 650 mm - 3"	1

Pinza pappagallo automatica



L=250
mm ACCIAIO
CR-V

CODICE	DESCRIZIONE	Q.TÀ
C7160	LUNGHEZZA 250 mm	10

Mini pinza a becco curvo fine



L=125
mm

CODICE	DESCRIZIONE	Q.TÀ
CX0131	LUNGHEZZA 125 mm	12

Set 4 pinze per anelli di sicurezza



L=160 mm

CODICE	DESCRIZIONE	Q.TÀ
C7100	LUNGHEZZA 160 mm	5

Mini pinza



L=125 mm

CODICE	DESCRIZIONE	Q.TÀ
CX0125	LUNGHEZZA 125 mm	12

Mini tronchese taglio diagonale



L=125 mm

CODICE	DESCRIZIONE	Q.TÀ
CX0127	LUNGHEZZA 125 mm	12

Mini tronchese taglio frontale



L=125 mm

CODICE	DESCRIZIONE	Q.TÀ
CX0128	LUNGHEZZA 125 mm	12

Mini pinza a becco dritto fine



L=125 mm

CODICE	DESCRIZIONE	Q.TÀ
CX0126	LUNGHEZZA 125 mm	12

Mini pinza a becco tondo



L=125 mm

CODICE	DESCRIZIONE	Q.TÀ
CX0130	LUNGHEZZA 125 mm	12

Set mini pinze



L=125 mm

CODICE	DESCRIZIONE	Q.TÀ
CX0140	LUNGHEZZA 125 mm	12

Pinza grip autobloccante



L=250 mm

CODICE	DESCRIZIONE	Q.TÀ
CB7140	LUNGHEZZA 250 mm	6

Pinze di serraggio con ganasce



L=180 mm

L=250 mm

CODICE	DESCRIZIONE	Q.TÀ
C7139	LUNGHEZZA 180 mm	12
C7140	LUNGHEZZA 250 mm	12

Pinze di serraggio con ganasce Allungate



L=230 mm

CODICE	DESCRIZIONE	Q.TÀ
C7141	LUNGHEZZA 230 mm	12

Pinze di serraggio con ganasce Per filtro olio



L=250 mm

CODICE	DESCRIZIONE	Q.TÀ
C7142	LUNGHEZZA 250 mm	12

Pinza di serraggio con ganasce tipo "U"



L=250 mm

CODICE	DESCRIZIONE	Q.TÀ
C7143	APERTURA FINO A 50 mm	12

Pinze di serraggio con ganasce larghe



L=250 mm

CODICE	DESCRIZIONE	Q.TÀ
C7144	APERTURA FINO A 40 mm	12

Pinza di serraggio con ganasce tipo "C"



L=280 mm

CODICE	DESCRIZIONE	Q.TÀ
C7146	APERTURA FINO A 80 mm	12

Morsa in ghisa

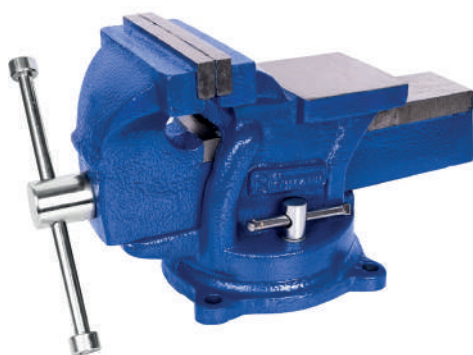

CODICE	DESCRIZIONE	Q.TÀ
C8104	LUNGHEZZA 100 mm 5KG	1
C8105	LUNGHEZZA 125 mm 7KG	1
C8106	LUNGHEZZA 150 mm 10KG	1
C8107	LUNGHEZZA 200 mm 17KG	1

Cacciaviti rotanti professionali calamitati



CODICE	DESCRIZIONE	Q.TÀ
C5243	CACCIAVITI ROTANTI PROFESSIONALI CALAMITATI	12

Cacciaviti professionali calamitati

calamitati



ACCIAIO CR-MO

CODICE	DESCRIZIONE	Q.TÀ
C5241	CACCIAVITI PROFESSIONALI CALAMITATI	12

Giraviti

ACCIAIO CR-MO



✕

CODICE	DESCRIZIONE	Q.TÀ
C5401	GIRAVITI A CROCE PHILLIPS 0x100 mm	12
C5402	GIRAVITI A CROCE PHILLIPS 1x100 mm	12
C5403	GIRAVITI A CROCE PHILLIPS 2x38 mm	12
C5404	GIRAVITI A CROCE PHILLIPS 2x100 mm	12
C5405	GIRAVITI A CROCE PHILLIPS 2x150 mm	12
C5406	GIRAVITI A CROCE PHILLIPS 3x150 mm	12

+

CODICE	DESCRIZIONE	Q.TÀ
C5412	GIRAVITI A CROCE POZIDRIV 1x100 mm	12
C5414	GIRAVITI A CROCE POZIDRIV 2x100 mm	12

⌘

CODICE	DESCRIZIONE	Q.TÀ
C5421	GIRAVITI A TAGLIO 3x100 mm	12
C5422	GIRAVITI A TAGLIO 4x100 mm	12
C5423	GIRAVITI A TAGLIO 5x100 mm	12
C5424	GIRAVITI A TAGLIO 6x38 mm	12
C5425	GIRAVITI A TAGLIO 6x100 mm	12
C5426	GIRAVITI A TAGLIO 8x150 mm	12

Giraviti lunghi



ACCIAIO
CR-MO

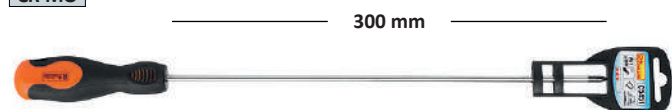

CODICE	DESCRIZIONE	Q.TÀ
C5450	CROCE PHILLIPS LUNGO 0x300 mm	12
C5451	CROCE PHILLIPS LUNGO 1x300 mm	12
C5452	CROCE PHILLIPS LUNGO 2x300 mm	12



CODICE	DESCRIZIONE	Q.TÀ
C5454	TAGLIO LUNGO 3x300 mm	12
C5455	TAGLIO LUNGO 4x300 mm	12
C5456	TAGLIO LUNGO 5x300 mm	12
C5457	TAGLIO LUNGO 6x300 mm	12

Giraviti TORX



ACCIAIO
CR-MO

CODICE	DESCRIZIONE	Q.TÀ
C5460	TORX 5x75 mm	12
C5461	TORX 6x75 mm	12
C5462	TORX 7x75 mm	12
C5463	TORX 8x75 mm	12
C5464	TORX 9x75 mm	12
C5465	TORX 10x100 mm	12
C5466	TORX 15x100 mm	12
C5467	TORX 20x100 mm	12
C5468	TORX 25x100 mm	12
C5469	TORX 27x100 mm	12
C5470	TORX 30x100 mm	12
C5471	TORX 40x100 mm	12
C5472	TORX 45x100 mm	12

Giraviti 2 in 1 con inserto combinato PH2 E taglio 6 mm lunghezza 100 mm



ACCIAIO
CR-MO

CODICE	DESCRIZIONE	Q.TÀ
C5365	2 IN 1 CON INSERTO COMBINATO PH2 E TAGLIO 6 mm	6

Giraviti isolato per elettricisti



ACCIAIO
CR-V



CODICE	DESCRIZIONE	Q.TÀ
C5303	PHILLIPS 0x80 mm	12
C5304	PHILLIPS 1x100 mm	12
C5305	PHILLIPS 2x125 mm	12



CODICE	DESCRIZIONE	Q.TÀ
C5306	TAGLIO 3x80 mm	12
C5307	TAGLIO 4x100 mm	12
C5308	TAGLIO 5x100 mm	12
C5309	TAGLIO 6x125 mm	12

Cercafase



CE

AC 100-500 V

CODICE	DESCRIZIONE	Q.TÀ
C5265	TAGLIO 140 mm	30
C5266	TAGLIO 190 mm	24

Cercafase digitale



CE

DC AC 12-250 V

CODICE	DESCRIZIONE	Q.TÀ
C5252	CERCAFASE DIGITALE CON DISPLAY	24

Set giraviti



ACCIAIO
CR-V

CODICE	DESCRIZIONE	Q.TÀ
C5370	PH0 – PH1 – PH2 – TAGLIO 4 – TAGLIO 5 – TAGLIO 6	5
C5371	PZ0 – PZ1 – PZ2 – TAGLIO 4 – TAGLIO 5 – TAGLIO 6	5
C5375	TX6- TX8 – TX10 – TX15 – TX20 – TX25 – TX30	5

Assortimento giraviti isolato



CODICE	DESCRIZIONE	Q.TÀ
C5301	PH1- PH2- TAGLIO 3- TAGLIO 4- TAGLIO 6- CERCAFASE	5

Assortimento mini giraviti
PH – taglio



CODICE	DESCRIZIONE	Q.TÀ
C5366	PH000 – PH 00 – PH 0 – TAGLIO 1,5 – TAGLIO 2,0 – TAGLIO 2,4	5

Assortimento mini giraviti
TORX



CODICE	DESCRIZIONE	Q.TÀ
C5367	TX: T5 – T6- T7 – T8 – T9 – T10	5

Espositore da banco giraviti PZ - PH - taglio 168PZ



CODICE	NUMERO	DIMENSIONE
C5401	12	PH 0X100
C5402	12	PH 1X100
C5403	12	PH 2X38
C5404	12	PH 2X100
C5405	12	PH 2X150
C5406	12	PH 3X150
C5412	12	PZ 1X100
C5414	12	PZ 2X100
C5421	12	3X100
C5422	12	4X100
C5423	12	5X100
C5424	12	6X38
C5425	12	6X100
C5426	12	8X150

CODICE	DESCRIZIONE	Q.TÀ
CZ10	ESPOSITORE DA BANCO GIRAVITI PZ- PH- TAGLIO 168PZ	1



SPOSTA OGGETTI

BREMAK SRL [®]

PRESENTA

FERMASCURO MAGNETICO

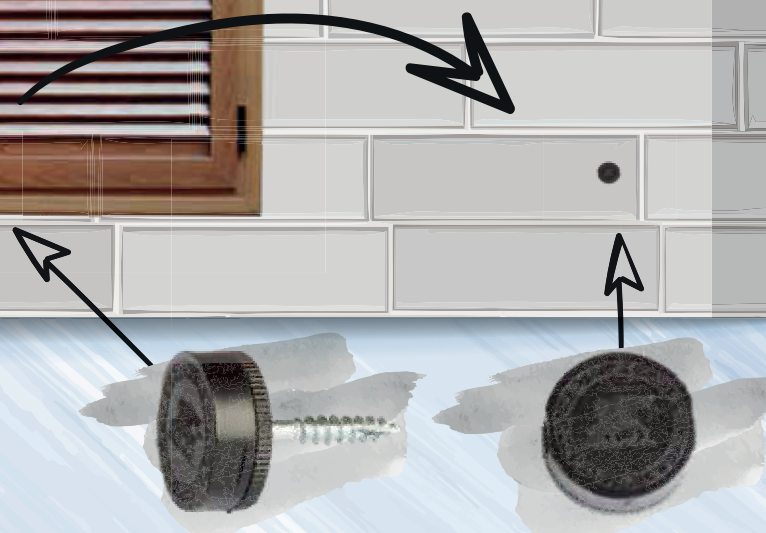
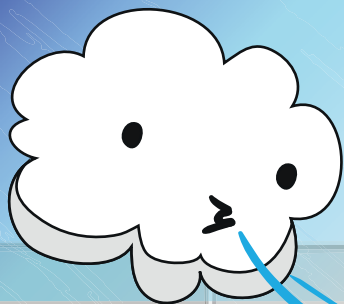

COPPIA FERMABALCONI MAGNETICI

COLORI DISPONIBILI

**MAX TENUTA
E PRATICITA'**

CODICE	DESCRIZIONE	Q.TÀ
TCFSNERO	COPPIA FERMASCURO MAGNETICO NERO	20
TCFSBIANCO	COPPIA FERMASCURO MAGNETICO BIANCO	20
TCSFGRIGIO	COPPIA FERMASCURO MAGNETICO GRIGIO	20

Cuscinetto gonfiabile winbag



150x160 mm 100KG 3-50 mm

CODICE	DESCRIZIONE	Q.TÀ
107048822	CUSCINETTO GONFIABILE WINBAG	24
107048823	POMPETTA PER CUSCINETTO GONFIABILE	4

Serie strettoi stringe e allarga

NEW



CODICE	DESCRIZIONE	Q.TÀ
C2020	MORSETTO FALEGNAMERIA RAPID 150 mm 149KG	12
C2021	MORSETTO FALEGNAMERIA RAPID 300 mm 149KG	12
C2022	MORSETTO FALEGNAMERIA RAPID 450 mm 149KG	12
C2023	MORSETTO FALEGNAMERIA RAPID 600 mm 149KG	12
C2024	MORSETTO FALEGNAMERIA RAPID 750 mm 149KG	12
C2025	MORSETTO FALEGNAMERIA RAPID 900 mm 149KG	12

Cuscinetto gonfiabile



CODICE	DESCRIZIONE	Q.TÀ
YT-67381	DIMENSIONI 165X150 mm	24
YT-67382	DIMENSIONI 190X110 mm	24
YT-67383	DIMENSIONI 270X130 mm	24
YT-67385	ASSORTIMENTO 3 CUSCINETTI	6

Pattini spostaoggetti + solleva porta



300KG

CODICE	DESCRIZIONE	Q.TÀ
YT-37490	4PZ PATTINI SPOSTAOGGETTI 300KG E SOLLEVA PORTA	6

Solleva piastrelle



100 mm

CODICE	DESCRIZIONE	Q.TÀ
YT-37200	ALZATA 100 mm	6

Disco sposta oggetti



ANTISCIVOLO

TEFLON

CODICE	DESCRIZIONE	Q.TÀ
1077400	40 mm (4PZ)	24
1077600	60 mm (4PZ)	24

Coppia porta lastre con impugnatura



YATO

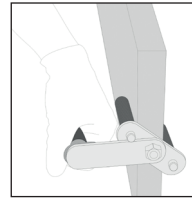

CODICE	DESCRIZIONE	Q.TÀ
YT-37440	COPPIA PORTA LASTRE CON IMPUGNATURA	6

Carrello in alluminio pieghevole

YATO



70KG

CODICE	DESCRIZIONE	Q.TÀ
11003175	PORTATA MASSIMA 70 KG	4

Porta lastre



80KG

ABS

CODICE	DESCRIZIONE	Q.TÀ
YT-37444	PORTATA MASSIMA 80 KG	6

Scivolo maschio/femmina colore giallo per piastrelle marina

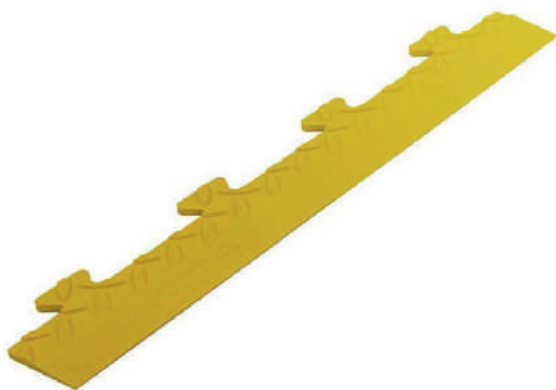

4000
KG/M²

CODICE	DESCRIZIONE	Q.TÀ
SPMPG50/M	SCIVOLO MASCHIO COLORE GIALLO 480X51X10 mm PER PIASTRELLE MARINA	10
SPMPG50/F	SCIVOLO FE mmINA COLORE GIALLO 480X51X10 mm PER PIASTRELLE MARINA	10

Espositore 92 piastrelle marina



CODICE	DESCRIZIONE	Q.TÀ
PMPN50	PIASTRELLA MARINA IN PVC MORBIDA ANTISCIVOLO 500X500X10 mm	92

Spessore per vetro e finestre

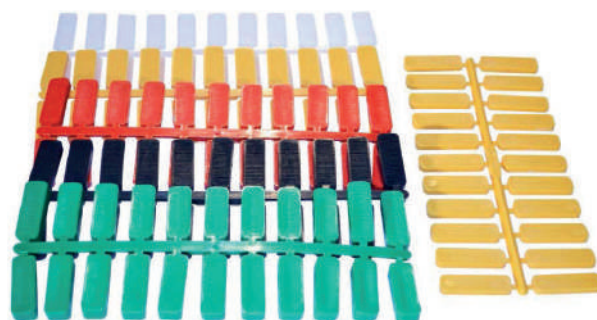

CODICE	DESCRIZIONE	Q.TÀ
PSPE30X18X2PPC	30X18X2 mm BIANCO	12
PSPE30X18X3PPC	30X18X3 mm GIALLO	12
PSPE30X18X4PPC	30X18X4 mm ROSSO	12
PSPE30X18X5PPC	30X18X5 mm NERO	12
PSPE30X18X7PPC	30X8X7 mm VERDE	12

Claps



CODICE	DESCRIZIONE	Q.TÀ
PCLAPS200000PPC	CLAPS 2 mm NEUTRO	1000
PCLAPS300000PPC	CLAPS 3 mm GRIGIO	800
PCLAPS500000PPC	CLAPS 5 mm NERO	500

Pozzetto antipolvere nichelato



CON MOLLA

CODICE	DESCRIZIONE	Q.TÀ
A3008NI	15X30XØ8 mm CON MOLLA	100
A3009NI	20X30XØ9 mm CON MOLLA	100
A3010NI	20X30XØ10 mm CON MOLLA	100
A2508NI	20X30XØ8 mm SENZA MOLLA	100
A2509NI	20X30XØ9 mm SENZA MOLLA	100
A2510NI	20X25XØ10 mm SENZA MOLLA	100

Cassaforte con digital lock

Sistema di avviso di batteria scarica

NEW



CODICE	DESCRIZIONE	Q.TÀ	
TO-78641	ALIMENTATO DA 4 BATTERIE AA (1,5 V) CON DOPPIA CHIAVE	1	
	MISURE		350X250X250 mm
	LAMIERA D'ACCIAIO		10 KG

Cassaforte con digital lock

Sistema di avviso di batteria scarica

NEW



CODICE	DESCRIZIONE	Q.TÀ	
TO-78642	ALIMENTATO DA 4 BATTERIE AA (1,5 V) CON DOPPIA CHIAVE	1	
	MISURE		310X200X200 mm
	LAMIERA D'ACCIAIO		7 KG



RIVETTI

Rivettatrice



L=250 mm

CODICE	DESCRIZIONE		Q.TÀ
C0705	RIVETTATRICE PROFESSIONALE		6
	RIVETTI	2,4- 3,2- 4,0- 4,8 (mm)	

Rivettatrice professionale rotante



L=275 mm

CODICE	DESCRIZIONE		Q.TÀ
C0707	RIVETTATRICE PROFESSIONALE		6
	RIVETTI	2,4- 3,2- 4,0- 4,8 (mm)	

Rivettatrice professionale



L=215 mm

CODICE	DESCRIZIONE		Q.TÀ
C0708	RIVETTATRICE PROFESSIONALE		6
	USO DEI RIVETTI	ALLUMINIO: 2,4- 3,2- 4,0- 4,8 (mm)	
		ACCIAIO: 2,4- 3,2- 4,0 (mm)	
		ACCIAIO INOX: 2,4- 3,2- 4,0- 4,8 (mm)	

Rivettatrice professionale a due mani



L=260 mm

CODICE	DESCRIZIONE		Q.TÀ
CXT0801	RIVETTATRICE PROFESSIONALE		6
	RIVETTI	2,4- 3,2- 4,0- 4,8- 6,4 (mm)	

Rivettatrice professionale a due mani



L=550 mm

CODICE	DESCRIZIONE		Q.TÀ
C0730	RIVETTATRICE PROFESSIONALE A DUE MANI		6
	RIVETTI	3,2- 4,- 4,8- 6,0- 6,4 (mm)	

Rivettatrice professionale per Rivetti filettati



L=195 mm

CODICE	DESCRIZIONE		Q.TÀ
C0709	RIVETTATRICE PROFESSIONALE PER RIVETTI		6
	DIMENSIONI DADO RIVETTO	M3, M4, M5, M6	

Rivettatrice professionale a due mani per rivetti filettati



L=440 mm

CODICE	DESCRIZIONE		Q.TÀ
C0745	RIVETTATRICE PROFESSIONALE A DUE MANI		6
	RIVETTI	M3- M4- M5- M6- M8- M10- M12	
	TIPO DADO	ALLUMINIO-ACCIAIO-ACCIAIO INOSSIDABILE	

Testa di ricambio per rivettatrice rivetti filettati



CODICE	DESCRIZIONE	Q.TÀ
C0751	PER RIVETTATRICE C0709 E C0745 DA M3	10
C0752	PER RIVETTATRICE C0709 E C0745 DA M4	10
C0753	PER RIVETTATRICE C0709 E C0745 DA M5	10
C0754	PER RIVETTATRICE C0709 E C0745 DA M6	10
C0755	PER RIVETTATRICE C0709 E C0745 DA M8	10
C0756	PER RIVETTATRICE C0709 E C0745 DA M10	10
C0757	PER RIVETTATRICE C0709 E C0745 DA M12	10

Rivettatrice pneumatica



NEW

CODICE	DESCRIZIONE		Q.TÀ
TO-70280	PRESSIONE	76,1 ± 3,0 DB(A)	10
	DIAMETRO DEL RIVETTO	2,4, 3,2,4, 4,8 mm	
	PRESSIONE MAX	0,63 MPA	
	SCHIACCIAMENTO	720KG	
	PESO	1,5KG	
	DIAMETRO INTERNO DEL TUBO	3/8" (10 mm)	

Rivetto alluminio chiodo acciaio zincato

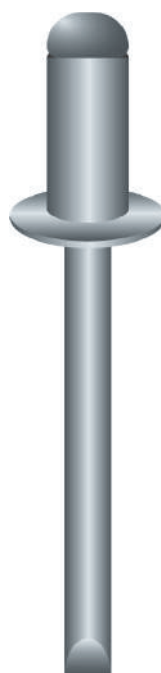

d mm	L mm	D mm	mm	mm	N	N
3	6 8 10	6	3,1	2÷3 3÷5 5÷7	1100	660
3,2	8	6,5	3,3	3÷5	950	680
3,4	7 9	7	3,5	3÷4 4÷6	1500	850
4	8 10 12 14 16	8	4,1	2,5÷4,5 4,5÷6,5 6,5÷8,5 8,5÷10,5 10,5÷12,5	1850	1300
4,8	10 12 14 16 20	9,5	5	4÷6 6÷8 8÷10 10÷12 14÷16	2950	2170

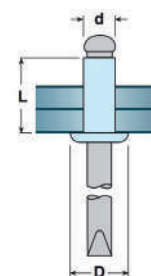

ACCIAIO ZINCATO

CODICE	DESCRIZIONE	Q.TÀ
S1013006-3X6	3x6 mm	1000
S1013008-3X8	3x8 mm	1000
S1013010-3X10	3x10 mm	1000
S1013208-3.2X8	3,2x8 mm	1000
S1013407-3.4X7	3,4x7 mm	1000
S1013409-3.4X9	3,4x9 mm	1000
S1014008-4X8	4x8 mm	1000
S1014010-4X10	4x10 mm	1000
S1014012-4X12	4x12 mm	1000
S1014014-4X14	4x14 mm	1000
S1014016-4X16	4x16 mm	500
S1014810-4.8X10	4,8x10 mm	500
S1014812-4.8X12	4,8x12 mm	500
S1014814-4.8X14	4,8x14 mm	500
S1014816-4.8X16	4,8x16 mm	500
S10148-4.8X20	4,8x20 mm	500

Rivetto alluminio chiodo acciaio zincato GRAF

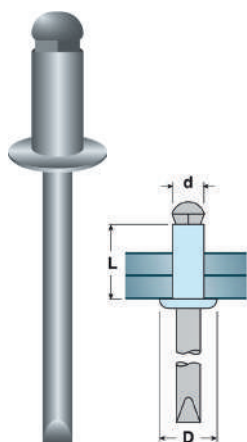

d mm	L mm	D mm	mm	mm	N	N
4	12 16 20 25 30	8	4,3	3÷6 6÷10 10÷14 14÷18 18÷24	1850	1300
4,8	12 16 20 26 30 35 40 50	9,5	5,3	2÷6 6÷10 10÷14 14÷18 18÷22 22÷27 27÷32 37÷42	2950	2170

ACCIAIO
ZINCATO

CODICE	DESCRIZIONE	Q.TÀ
S1214012-4.3X12	4,3x12 mm	1000
S1214016-4.3X16	4,3x16 mm	500
S1214020-4.3X20	4,3x20 mm	500
S1214026-4.3X25	4,3x25 mm	500
S1214030-4.3X30	4,3x30 mm	500
S1214812-4.8X12	4,8x12 mm	500
S1214816-4.8X16	4,8x16 mm	500
S1214820-4.8X20	4,8x20 mm	500
S1214826-4.8X26	4,8x26 mm	250
S1214830-4.8X30	4,8x30 mm	250
S1214835-4.8X35	4,8x35 mm	250
S1214840-4.8X40	4,8x40 mm	250
S1214850-4.8X50	4,8x50 mm	250

Rivetti in alluminio a testa larga

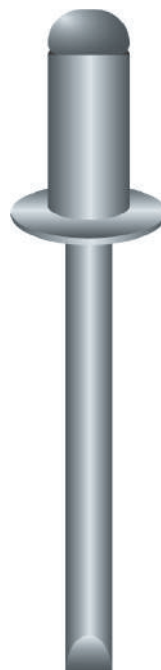

d mm	L mm	D mm	mm	mm	N	N
4,8	12 14 16 20	9,5	5	6÷8 8÷10 10÷12 14÷16	2950	2170

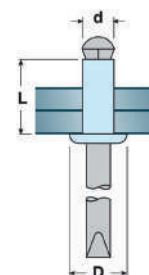

ACCIAIO
ZINCATO

CODICE	DESCRIZIONE	Q.TÀ
S1074812-4.8X12	4,8x12 mm	250
S1074814-4.8X14	4,8x14 mm	250
S1074816-4.8X16	4,8x16 mm	250
S1074820-4.8X20	4,8x20 mm	250

Inserti filettati a testa cilindrica



d 6H mm	D mm	B mm	S mm	mm	mm	L ₁ mm	L mm
M4	5,9	9	1	6	0,3÷2,5 2,5÷4,0	5,5÷6,0	11 13
M5	6,9	10	1,2	7	0,5÷3,0 3,0÷5,0	7,2÷7,7	13 15,5
M6	8,9	12	1,5	9	0,5÷2,3 2,3÷4,0 4,0÷6,0	7,6÷8,2	15,5 16 17,5
M8	10,9	15	1,5	11	0,8÷3,5 3,5÷6,0	9,5÷10,1	17,5 20
M10	11,9	16	1,7	12	1,0÷3,5 3,5÷6,0	10,7÷11,5	19 22

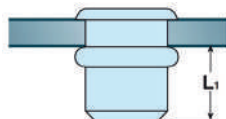
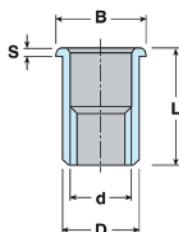

ACCIAIO
ZINCATO

CODICE	DESCRIZIONE	Q.TÀ
S1074812-4.8X12	IN ACCIAIO M4	200
S1074814-4.8X14	IN ACCIAIO M5	200
S1074816-4.8X16	IN ACCIAIO M6	200
S1074820-4.8X20	IN ACCIAIO M8	200
S32M10TP-C-M10	IN ACCIAIO M10	200

Inserto filettato esagonale a testa ridotta

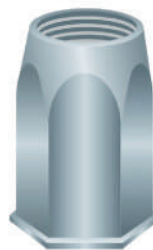

d 6H mm	M mm	B mm	S mm	M ₁ mm	mm	L ₁ mm	L mm
M4	5,9	6,6	0,5	6	0,5÷2,0	5,5÷6,0	11
M5	6,9	8	0,6	7	0,5÷3,0	7,6÷8,3	14
M6	8,9	10	0,6	9	0,5÷3,0	10,3÷10,7	16
M8	10,9	12	0,8	11	0,5÷3,0	11,8÷12,5	18

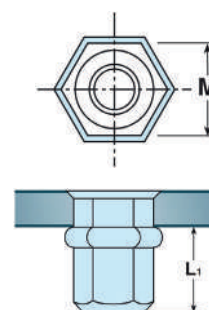
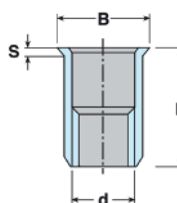

ACCIAIO
ZINCATO

CODICE	DESCRIZIONE	Q.TÀ
S32M4TRE-M4	IN ACCIAIO M4	200
S32M5TRE-M5	IN ACCIAIO M5	200
S32M6TRE-M6	IN ACCIAIO M6	200
S32M8TRE-M8	IN ACCIAIO M8	200
S32M10TRE-M10	IN ACCIAIO M10	200

Ingrassatore manuale



CODICE	DESCRIZIONE		Q.TÀ
C0720	INGRASSATORE MANUALE DA 500 MI + 2 TUBI		5
	PRESSIONE DI ESERCIZIO	200-410 BAR	
		20-41 MPA	
		3000-6000 PSI	
	CAPACITÀ	500 GR	
FILETTATURA	M10		

Ingrassatore manuale professionale



CODICE	DESCRIZIONE		Q.TÀ
C0722	INGRASSATORE MANUALE DA 500 MI PROFESSIONALE + 2 TUBI		5
	PRESSIONE DI ESERCIZIO	310- 850 BAR	
		31- 82 MPA	
		4500- 1200 PSI	
	CAPACITÀ	500 GR	
	FILETTATURA	M10	
SPESSORE CORPO	1,3 mm		

Ingrassatore manuale



CODICE	DESCRIZIONE		Q.TÀ
C0725	INGRASSATORE MANUALE DA 600 MI PROFESSIONALE + 2 TUBI		5
	PRESSIONE DI ESERCIZIO	400-965 BAR	
		41-96 MPA	
		6000-14000 PSI	
	CAPACITÀ	600 GR	
FILETTATURA	M10		
SPESSORE CORPO	1,7 mm		

Grasso al litio in cartuccia



400 GR

CODICE	DESCRIZIONE	Q.TÀ
C0715	400 MI PER ARTICOLI C0722 E C0725	10

Tubo flessibile per ingrassatore



MAX 4500 PSI

M10X1

CODICE	DESCRIZIONE	Q.TÀ
C0760	TUBO PER INGRASSATORE LUNGHEZZA 300 mm	10
C0761	TUBO PER INGRASSATORE LUNGHEZZA 500 mm	10

Tubo flessibile per ingrassatore professionale



M10X1

CODICE	DESCRIZIONE	Q.TÀ
C0765	LUNGHEZZA 300 mm	10
C0766	LUNGHEZZA 500 mm	10

Tubo metallo per ingrassatore

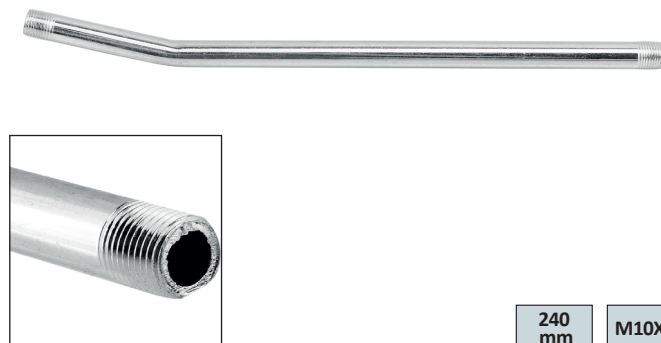

240 mm

M10X1

CODICE	DESCRIZIONE	Q.TÀ
C0770	LUNGHEZZA 240 mm	10

Testine quattro griffe diritte in acciaio

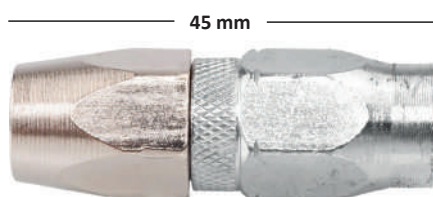

M10X1

CODICE	DESCRIZIONE	Q.TÀ
C0780	TESTINE A QUATTRO GRIFFE DIRITTE IN ACCIAIO	10

Iniettore di olio manuale



500 MI

M10X1

CODICE	DESCRIZIONE	Q.TÀ
C0703	500 MI	5

Oliatore manuale in metallo



250MI

500MI

CODICE	DESCRIZIONE	Q.TÀ
C0697	CANNA SEMIFLESSIBILE 250 MI	10
C0696	CANNA SEMIFLESSIBILE 500 MI	10
C0698	CANNA FLESSIBILE 380 MI	10

Pistola olio



NEW

CODICE	DESCRIZIONE	Q.TÀ
C0863	FUNZIONAMENTO 15 BAR	10
	CONNETTORE 1/4" SERBATOIO 900 MI	



FILIERE ESTRATTORI E LIME

Maschi filettatura standard



DIN 352

ACCIAIO
SI-CR

CODICE	DESCRIZIONE	Q.TÀ
C9003	M3x0,5 CONFEZIONE DA 3PZ	10
C9004	M4x0,7 CONFEZIONE DA 3PZ	10
C9005	M5x0,8 CONFEZIONE DA 3PZ	10
C9006	M6x1 CONFEZIONE DA 3PZ	10
C9008	M8x1,25 CONFEZIONE DA 3PZ	10
C9010	M10x1,5 CONFEZIONE DA 3PZ	10
C9012	M12x1,75 CONFEZIONE DA 3PZ	10
C9014	M14x2 CONFEZIONE DA 3PZ	10
C9016	M16x2 CONFEZIONE DA 3PZ	10
C9018	M16x2,5 CONFEZIONE DA 3PZ	10
C9020	M20x2,5 CONFEZIONE DA 3PZ	10

Maschi filettatura a passo fine



DIN 2181

ACCIAIO
SI-CR

CODICE	DESCRIZIONE	Q.TÀ
C9071	M4x0,5 CONFEZIONE DA 2PZ	10
C9072	M5x0,5 CONFEZIONE DA 2PZ	10
C9073	M6x0,75 CONFEZIONE DA 2PZ	10
C9075	M8x1 CONFEZIONE DA 2PZ2PZ	10
C9076	M10x0.75 CONFEZIONE DA 2PZ	10
C9076	M10x0.75 CONFEZIONE DA 2PZ	10
C9077	M10x1 CONFEZIONE DA 2PZ	10
C9078	M12x1,75 CONFEZIONE DA 3PZ	10
C9079	M10x1,25 CONFEZIONE DA 2PZ	10
C9080	M12x1,25 CONFEZIONE DA 2PZ	10
C9081	M12x1,5 CONFEZIONE DA 2PZ	10
C9082	M14x1 CONFEZIONE DA 2PZ	10
C9083	M14x1,25 CONFEZIONE DA 2PZ	10
C9084	M14x1,5 CONFEZIONE DA 2PZ	10
C9085	M16x1 CONFEZIONE DA 2PZ	10
C9086	M16x1,25 CONFEZIONE DA 2PZ	10
C9087	M16x1,5 CONFEZIONE DA 2PZ	10

Maschi filettatura standard



DIN 376A

ACCIAIO
M2

CODICE	DESCRIZIONE	Q.TÀ
C9021	M3x0,5 DIN371A/376A	5
C9022	M4x0,7 DIN371A/376A	5
C9023	M5x0,8 DIN371A/376A	5
C9024	M6x1 DIN371A/376A	5
C9025	M7x1 DIN371A/376A	5
C9026	M8 X1,25 DIN371A/376A	5
C9027	M10 X1,5 DIN371A/376A	5
C9028	M12X1,75 DIN371A/376A	5

Filiera tonda filettatura standard

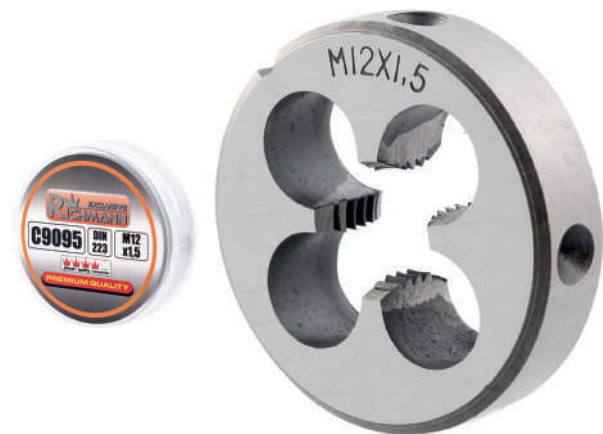

DIN 223

ACCIAIO
SI-CR

Filiera tonda filettatura a passo fine



DIN 223

ACCIAIO
SI-CR

CODICE	DESCRIZIONE	Q.TÀ
C9093	M8x1 D. 2,5 CM	10
C9094	M10x1,25 D 3CM	10
C9095	M12x1,5 D. 4CM	10
C9096	M14x1,5 D. 4CM	10
C9097	M16x1,5 D 4,5CM	10

CODICE	DESCRIZIONE	Q.TÀ
C9053	M3x0,5 Ø 2 CM	10
C9054	M4x0,7 Ø 2 CM	10
C9055	M5x0,8 Ø 2 CM	10
C9056	M6x1 Ø 2 CM	10
C9058	M8x1,25 Ø 2,5 CM	10
C9060	M10x1,5 Ø 3 CM	10
C9062	M12x1,75 Ø 4 CM	10
C9064	M14x2 Ø 4 CM	10
C9066	M16x2 Ø 4,5 CM	10
C9068	M18x2,5 Ø 4,5 CM	10
C9070	M20x2,5 Ø 4,5 CM	10

Manopola per il maschio



CODICE	DESCRIZIONE	Q.TÀ
C9000	M1-M12	10
C9001	M5-M20	10

Chiave giramaschi a cricchetto



CODICE	DESCRIZIONE	Q.TÀ
C9002	M5-M12	10

Portafiliera



CODICE	DESCRIZIONE	Q.TÀ
C9041	M4-M6	10
C9042	M8	10
C9043	M10	10
C9044	M12-M14	10
C9045	M16	10

Set maschi + manopola



DIN 352

ACCIAIO SI-CR

CODICE	DESCRIZIONE	Q.TÀ	
C9181	SET FILIERE M3-M12 + PORTAFILIERE 22PZ	10	
	MANOPOLA MASCHI		1PZ
	MASCHI		(M3,M4,M5,M6,M8,M10,M12)X3PZ
	DIMENSIONI		150X110X35 mm

Set filiere + portafiliera



DIN 352

ACCIAIO SI-CR

CODICE	DESCRIZIONE	Q.TÀ	
C9180	SET FILIERE M3-M12 + PORTAFILIERE 8PZ	5	
	PORTAFILIERE		1PZ
	FILIERE		(M3X0,5; M4X0,7; M5X0,8; M6X1; M8X1,25; M10X1,5; M12X1,75)X3PZ
	DIMENSIONI		120X80X30 mm

Set maschi e filiere + manopola + portafiliera + accessori



DIN 223

DIN 352

ACCIAIO SI-CR

CODICE	DESCRIZIONE	Q.TÀ	
C9182	SET MASCHI E FILIERE M3-M12 + MANOPOLA E PORTAFILIERE + ACCESSORI 32PZ	5	
	MANOPOLA E PORTAFILIERE		1PZ
	FILIERE E MASCHI		M3,M4,M5,M6,M8,M10,M12
	DIMENSIONI		265X120X35 mm

Set maschi e filiere + manopola + portafiliera + accessori



DIN 223
DIN 352

ACCIAIO
SI-CR

CODICE	DESCRIZIONE		Q.TÀ
C9183	SET MASCHI E FILIERE M3-M20 + MANOPOLA E PORTAFILIERE + ACCESSORI 54PZ		1
	MANOPOLA(2PZ) E PORTAFILIERE(6PZ)		
	FILIERE E MASCHI	M3,M4,M5,M6,M8,M10,M12,M14,M16,M18,M20	
	DIMENSIONI	510X235X50 mm	
	SONDA E CACCIAVITE	1PZ	

Estrattore vite set da 5PZ m3-m18



ACCIAIO
CR-V

CODICE	DESCRIZIONE		Q.TÀ
C9190	ESTRATTORE VITE SET 5 PZ M3-M18		10
	GRANDEZZE	M3-M6 1/8-1/4"; M6-M8 1/4-5/16"; M8-M11 5/16-7/16"; M11-M14 7/16-9/16"; M14-M18 9/16-3/4"	

Estrattore vite set da 6 PZ m3-m25



ACCIAIO
CR-V

CODICE	DESCRIZIONE		Q.TÀ
C9191	ESTRATTORE VITE SET 6 PZ M3-M25-		10
	GRANDEZZE	M3-M6 1/8-1/4"; M6-M8 1/4-5/16"; M8-M11 5/16-7/16"; M11-M14 7/16-9/16"; M14-M18 9/16-3/4"; M18-M25	

Estrattore vite set da 8 PZ m3-m50



ACCIAIO
CR-V

CODICE	DESCRIZIONE	Q.TÀ
C9192	ESTRATTORE VITE SET 8 PZ M3-M50	10
	MISURE M3-M6 1/8-1/4"; M6-M8 1/4-5/16"; M8-M11 5/16-7/16"; M11-M14 7/16-9/16"; M14-M18 9/16-3/4"; M18-M25 3/4-1"; M18-M25 1-1 3/8"; M33-M50 1 3/8-2"	

Lima piatta nr.2 Per ferro



ACCIAIO
CR-MO

CODICE	DESCRIZIONE	Q.TÀ
C4934	LUNGHEZZA 200 mm	12
C4937	LUNGHEZZA 250 mm	12

Lima semitonda nr.2 Per metallo



ACCIAIO
CR-MO

CODICE	DESCRIZIONE	Q.TÀ
C4944	LUNGHEZZA 200 mm	12
C4947	LUNGHEZZA 250 mm	12

Lima tonda nr.2 Per metallo



ACCIAIO
CR-MO

CODICE	DESCRIZIONE	Q.TÀ
C4964	LUNGHEZZA 200 mm	12
C4967	LUNGHEZZA 250 mm	12

Lima triangolare nr.2 Per metallo



ACCIAIO
CR-MO

CODICE	DESCRIZIONE	Q.TÀ
C4954	LUNGHEZZA 200 mm	12
C4957	LUNGHEZZA 250 mm	12

Lima piatta nr.2 Per legno

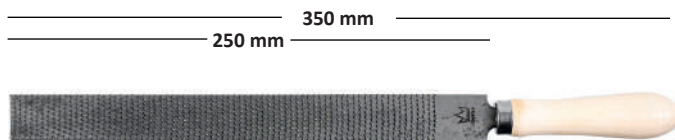

ACCIAIO
CR-MO

CODICE	DESCRIZIONE	Q.TÀ
C4921	LUNGHEZZA 250 mm	12

Lima semitonda nr.2 Per legno

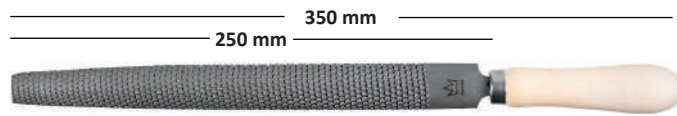

ACCIAIO
CR-MO

CODICE	DESCRIZIONE	Q.TÀ
C4924	LUNGHEZZA 250 mm	12

Lima tonda nr.2 Per legno

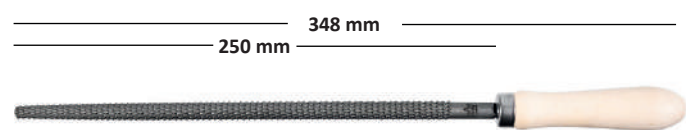

ACCIAIO
CR-MO

CODICE	DESCRIZIONE	Q.TÀ
C4927	LUNGHEZZA 250 mm	12

Set lime per ferro



CODICE	DESCRIZIONE	Q.TÀ
C4990	SET LIME PER FERRO NR.2 L=200 mm 3PZ (TONDA; SEMICIRCOLARE; PIATTA)	5
C4994	SET LIME PER FERRO NR.2 L=250 mm 3PZ (TONDA; SEMICIRCOLARE; PIATTA)	5

Set scalpello per falegname con manico in legno



CODICE	DESCRIZIONE	Q.TÀ
CXT790200	SET SCALPELLO PER FALEGNAME MANICO IN LEGNO 4PZ	6

Scalpello per falegname con Manico in legno



CODICE	DESCRIZIONE	Q.TÀ
CXT790206	6 mm	6
CXT790208	8 mm	6
CXT790212	12 mm	6
CXT790214	14 mm	6
CXT790218	18 mm	6
CXT790220	20 mm	6
CXT790225	25 mm	6
CXT790232	32 mm	6
CXT790238	38 mm	6



PUNTE

Punta rettificata autocentrante dual

ACCIAIO
HSS

CODICE	DESCRIZIONE	Q.TÀ
C9700	1 mm	10
C9701	1.5 mm	10
C9702	2 mm	10
C9703	2.5 mm	10
C9704	3 mm	10
C9705	3.2 mm	10
C9706	3.5 mm	10
C9707	4 mm	10
C9708	4.2 mm	10
C9709	4.5 mm	10
C9710	4.8 mm	10
C9711	5 mm	10
C9712	5.2 mm	10
C9713	5.5 mm	10
C9714	6 mm	10
C9715	6.5 mm	10
C9716	7 mm	10
C9717	7.5 mm	10
C9718	8 mm	10
C9719	8.5 mm	10
C9720	9 mm	10
C9721	9.5 mm	10
C9722	10 mm	5
C9723	10.5 mm	5
C9724	11 mm	5
C9725	11.5 mm	5
C9726	12 mm	5
C9727	12.5 mm	5
C9728	13 mm	5
C9729	14 mm	1
C9730	15 mm	1
C9731	16 mm	1
C9732	17 mm	1
C9733	18 mm	1
C9734	19 mm	1
C9735	20 mm	1

Espositore punte rettificata dual



NEW

ACCIAIO
HSS

CODICE	ELEMENTI	DESCRIZIONE	Q.TÀ
CZ17	C9700	1 mm	10
	C9701	1,5 mm	10
	C9702	2 mm	10
	C9703	2,5 mm	10
	C9704	3 mm	10
	C9705	3,2 mm	10
	C9706	3,5 mm	10
	C9707	4 mm	10
	C9708	4,2 mm	10
	C9709	4,5 mm	10
	C9710	4,8 mm	10
	C9711	5 mm	10
	C9712	5,2 mm	10
	C9713	5,5 mm	10
	C9714	6 mm	10
	C9715	6,5 mm	10
	C9716	7 mm	10
	C9717	7,5 mm	10
	C9718	8 mm	10
	C9719	8,5 mm	10
	C9720	9 mm	10
	C9721	9,5 mm	10
	C9722	10 mm	10
	C9723	10,5 mm	10
	C9724	11 mm	10
	C9725	11,5 mm	10
	C9726	12	10
	C9727	12,5	10
C9728	13	10	

Set punte rettificate



ACCIAIO
HSS

CODICE	DESCRIZIONE	Q.TÀ
101302501113	25PZ Ø 1-13 0,5 mm	5
101302610150	150PZ Ø 1 A 10x0.5 mm	5

Set punte rettificate



ACCIAIO
HSS

CODICE	DESCRIZIONE	Q.TÀ
C9696	13PZ 1,5-6 mm	5
C9697	19PZ Ø 1-10x0,5 mm	5

Punta cobalto HSS-E DIN 338
rettificata autocentrante



5%
COB

ACCIAIO
HSS

CODICE	DESCRIZIONE	Q.TÀ
101307000030	0,3X3X19 mm	10
101307000040	0,4X5X20 mm	10
101307000050	0,5X6X22 mm	10
101307000060	0,6X7X24 mm	10
101307000070	0,7X9X28 mm	10
101307000080	0,8X10X30 mm	10
101307000090	0,9X11X32 mm	10
C9810	1 mm	10
C9815	1.5 mm	10
C9820	2 mm	10
C9825	2.5 mm	10
C9830	3 mm	10
C9832	3.2 mm	10
C9835	3.5 mm	10
C9840	4 mm	10
C9842	4.2 mm	10
C9845	4.5 mm	10
C9848	4.8 mm	10
C9850	5 mm	10
C9852	5.2 mm	10
C9855	5.5 mm	10
C9860	6 mm	10
C9865	6.5 mm	10
C9870	7 mm	10
C9875	7.5 mm	10
C9880	8 mm	10
C9885	8.5 mm	10
C9890	9 mm	10
C9895	9.5 mm	10
C9900	10 mm	10
C9905	10.5 mm	10
C9910	11 mm	10
C9915	11.5 mm	10
C9920	12 mm	10
C9925	12.5 mm	10
C9930	13 mm	10



C9700

Espositore punte cobalto

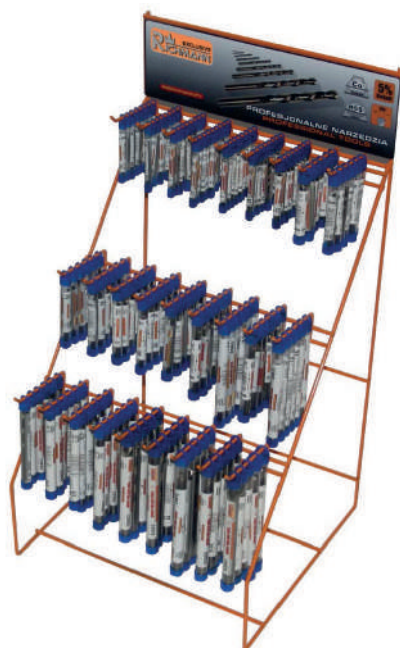
5%
COBACCIAIO
HSS

NEW

CODICE	ELEMENTI	DESCRIZIONE	Q.TÀ
Z03	C9810	1 mm	10
	C9815	1,5 mm	10
	C9820	2 mm	10
	C9825	2,5 mm	10
	C9830	3 mm	10
	C9832	3,2 mm	10
	C9835	3,5 mm	10
	C9840	4 mm	10
	C9842	4,2 mm	10
	C9845	4,5 mm	10
	C9848	4,8 mm	10
	C9850	5 mm	10
	C9852	5,2 mm	10
	C9855	5,5 mm	10
	C9865	6,5 mm	10
	C9870	7 mm	10
	C9875	7,5 mm	10
	C9880	8 mm	10
	C9885	8,5 mm	10
	C9890	9 mm	10
C9895	9,5 mm	10	
C9900	10 mm	10	
C9905	10,5 mm	10	
C9910	11 mm	10	
C9915	11,5 mm	10	
C9920	12	10	
C9925	12,5	10	
C9930	13	10	

Set punte cobalto

5%
COBACCIAIO
HSS

CODICE	DESCRIZIONE	Q.TÀ
C9801	19PZ Ø 1-10 IN 0,5 mm	5
101307501113	25PZ Ø 307/1-13 IN 0,5 mm	5

Punta rettificata - dual HSS-G M2 DIN 338
Speedmaster

CODICE	DESCRIZIONE	Q.TÀ
101001220100	1 mm	10
101001220150	1,50 mm	10
101001220200	2 mm	10
101001220250	2,5 mm	10
101001220300	3 mm	10
101001220350	3,50 mm	10
101001220400	4 mm	10
101001220450	4,50 mm	10
101001220500	5 mm	10
101001220550	5,5 mm	10
101001220600	6 mm	10
101001220650	6,50 mm	10
101001220700	7 mm	10
101001220750	7,50 mm	5
101001220800	8 mm	5
101001220850	8,50 mm	5
101001220900	9 mm	5
101001220950	9,50 mm	5
1010012201000	10 mm	5
1010012201050	10,50 mm	5
1010012201100	11 mm	5
1010012201150	11,50 mm	5
1010012201200	12 mm	5
1010012201250	12,50 mm	5
1010012201300	13 mm	5

Punta rettificata lunga HSS DIN 340



CODICE	DESCRIZIONE	Q.TÀ
C9280	3X99 mm	10
C9282	4X119 mm	10
C9284	5X130 mm	10
C9286	6X150 mm	10
C9288	8X165 mm	10
C9290	10X185 mm	10
101340000010	1,0X33X56 mm	10
101340000015	1,5X45X70 mm	10
101340000020	2,0X56X85 mm	10
101340000025	2,5X62X95 mm	10
101340000035	3,5X73X112 mm	10
101340000045	4,5X82X126 mm	10
101340000055	5,5X91X139 mm	10
101340000065	6,5X97X148 mm	5
101340000070	7,0X102X156 mm	5
101340000075	7,5X102X156 mm	5
101340000085	8,5X109X165 mm	5
101340000090	9,0X115X175 mm	5
101340000095	9,5X115X175 mm	5
101340000105	10,5X121X184 mm	5
101340000110	11,0X128X195 mm	5
101340000115	11,5X128X195 mm	5
101340000120	12,0X134X205 mm	5
101340000125	12,5X134X205 mm	5
101340000130	13,0X134X205 mm	5
101340000135	13,5X140X214 mm	3
101340000140	14,0X140X214 mm	3
101340000145	14,5X144X220 mm	3
101340000150	15,0X144X220 mm	3
101340000155	15,5X149X227 mm	3
101340000160	16,0X149X227 mm	3
101340000165	16,5X154X235 mm	1
101340000170	17,0X154X235 mm	1
101340000175	17,5X158X241 mm	1
101340000180	18,0X158X241 mm	1
101340000185	19,0X162X247 mm	1
101340000190	19,0X162X247 mm	1
101340000195	19,5X166X254 mm	1
101340000200	20,0X166X254 mm	1

Punta rettificata super corta HSS DIN 1897



CODICE	DESCRIZIONE	Q.TÀ
101305000300	3,0X16X35 mm	10
101305000320	3,2X19X40 mm	10
101305000325	3,25X19X40 mm	10
101305000330	3,3X19X40 mm	10
101305000350	3,5X19X40 mm	10
101305000360	3,6X19X40 mm	10
101305000375	3,75X19X40 mm	10
101305000400	4,0X20X40 mm	10
101305000410	4,1X20X40 mm	10
101305000425	4,25X20X40 mm	10
101305000450	4,5X23X42 mm	10
101305000500	5,0X23X42 mm	10

Punta rettificata, autocentrante HSS-G DIN 338 attacco 1/4"



CODICE	DESCRIZIONE	Q.TÀ
101306000150	1,5 mm	10
101306000200	2,0 mm	10
101306000250	2,5 mm	10
101306000300	3,0 mm	10
101306000350	3,5 mm	10
101306000400	4,0 mm	10
101306000450	4,5 mm	10
101306000500	5,0 mm	10
101306000550	5,5 mm	10
101306000600	6,0 mm	10
101306000650	6,5 mm	10
101306000700	7,0 mm	10
101306000750	7,5 mm	5
101306000800	8,0 mm	5
101306000850	8,5 mm	5
101306000900	9,0 mm	5
101306000950	9,5 mm	5
101306001000	10,0 mm	5

Punta rettificata extra lunga HSS DIN 1869



CODICE	DESCRIZIONE	Q.TÀ
C9283	4,0X220 mm	1
C9285	5,0X245 mm	1
C9287	6,0X260 mm	1
C9289	8,0X305 mm	1
C9291	10,0X340 mm	1
101342020125	2,0X85X125 mm	1
101342025140	2,5X95X140 mm	1
101342030150	3,0X100X150 mm	1
101342030190	3,0X130X190 mm	1
101342035165	3,5X115X165 mm	1
101342035210	3,5X145X210 mm	1
101342035265	3,5X180X265 mm	1
101342040175	4,0X120X175 mm	1
101342040280	4,0X190X280 mm	1
101342045185	4,5X125X185 mm	1
101342045235	4,5X160X235 mm	1
101342045295	4,5X200X295 mm	1
101342050195	5,0X135X195 mm	1
101342050245	5,0X170X245 mm	1
101342055205	5,5X140X205 mm	1
101342055260	5,5X180X260 mm	1
101342055330	5,5X225X330 mm	1
101342060205	6,0X140X205 mm	1
101342060260	6,0X180X260 mm	1
101342060330	6,0X225X330 mm	1
101342065215	6,5X150X215 mm	1
101342065275	6,5X190X275 mm	1
101342065350	6,5X235X350 mm	1
101342070225	7,0X155X225 mm	1
101342070290	7,0X200X290 mm	1
101342070370	7,0X250X370 mm	1
101342075225	7,5X155X225 mm	1
101342075290	7,5X200X290 mm	1
101342075370	7,5X250X370 mm	1
101342080240	8,0X165X240 mm	1
101342080305	8,0X210X305 mm	1
101342080390	8,0X265X390 mm	1
101342085240	8,5X165X240 mm	1
101342085305	8,5X210X305 mm	1
101342085390	8,5X265X390 mm	1
101342090250	9,0X175X250 mm	1
101342090320	9,0X220X320 mm	1
101342090410	9,0X280X410 mm	1
101342095250	9,5X175X250 mm	1

CODICE	DESCRIZIONE	Q.TÀ
101342095320	9,5X220X320 mm	1
101342095410	9,5X280X410 mm	1
101342100265	10,0X185X265 mm	1
101342100340	10,0X235X340 mm	1
101342100430	10,0X295X430 mm	1
101342105265	10,5X185X265 mm	1
101342105340	10,5X235X340 mm	1
101342105430	10,5X295X430 mm	1
101342110280	11,0X195X280 mm	1
101342110365	11,0X250X365 mm	1
101342110455	11,0X310X455 mm	1
101342115280	11,5X195X280 mm	1
101342040175	4,0X120X175 mm	1
101342040280	11,5X195X280 mm	1
101342115365	11,5X250X365 mm	1
101342115455	11,5X310X455 mm	1
101342120295	12,0X205X295 mm	1
101342120375	12,0X260X375 mm	1
101342120480	12,0X330X485 mm	1
101342125295	12,5X205X295 mm	1
101342125375	12,5X260X375 mm	1
101342125480	12,5X330X485 mm	1
101342130295	13,0X205X295 mm	1
101342130375	13,0X260X375 mm	1
101342130480	13,0X330X485 mm	1

Punta rettificata autocentrante HSS-G DIN 338
attacco HEX1/4

CODICE	DESCRIZIONE	Q.TÀ
101317000030	3,0 mm	5
101317000040	4,0 mm	5
101317000050	5,0 mm	5
101317000060	6,0 mm	5
101317000080	8,0 mm	5
101317000100	10,0 mm	5

Punta standard HSS DIN 338



ANGOLO
118°

ACCIAIO
HSS



CODICE	DESCRIZIONE	Q.TÀ
C9410	1 mm	10
C9415	1.5 mm	10
C9420	2 mm	10
C9421	2.1 mm	10
C9422	2.2 mm	10
C9423	2.3 mm	10
C9424	2.4 mm	10
C9426	2.6 mm	10
C9427	2.7 mm	10
C9428	2.8 mm	10
C9429	2.9 mm	10
C9430	3 mm	10
C9431	3.1 mm	10
C9432	3.2 mm	10
C9433	3.3 mm	10
C9434	3.4 mm	10
C9435	3.5 mm	10
C9436	3.6 mm	10
C9437	3.7 mm	10
C9438	3.8 mm	10
C9439	3.9 mm	10
C9440	4 mm	10
C9441	4.1 mm	10
C9442	4.2 mm	10
C9443	4.3 mm	10
C9444	4.4 mm	10
C9445	4.5 mm	10
C9446	4.6 mm	10
C9447	4.7 mm	10
C9448	4.8 mm	10
C9449	4.9 mm	10
C9451	5.1 mm	10
C9452	5.2 mm	10
C9453	5.3 mm	10
C9454	5.4 mm	10
C9455	5.5 mm	10
C9456	5.6 mm	10
C9457	5.7 mm	10
C9458	5.8 mm	10
C9459	5.9 mm	10
C9460	6 mm	10
C9461	6.1 mm	10
C9462	6.2 mm	10
C9463	6.3 mm	10

CODICE	DESCRIZIONE	Q.TÀ
C9464	6.4 mm	10
C9465	6.5 mm	10
C9468	6.8 mm	10
C9470	7 mm	5
C9475	7.5 mm	5
C9480	8 mm	10
C9482	8.2 mm	10
C9485	8.5 mm	10
C9490	9 mm	10
C9495	9.5 mm	10
C9500	10 mm	10
C9502	10.2 mm	10
C9505	10.5 mm	10
C9511	11 mm	10
C9515	11.5 mm	10
C9520	12 mm	10
C9525	12.5 mm	10
C9530	13 mm	10
C9540	14 mm C/RID. 13 mm	10
C9550	15 mm C/RID. 13 mm	10
C9560	16 mm C/RID. 13 mm	10
C9570	17 mm C/RID. 13 mm	10
C9580	18 mm C/RID. 13 mm	10
C9590	19 mm C/RID. 13 mm	10
C9599	20 mm C/RID. 13 mm	10

Espositore punte standard HSS



NEW

ANGOLO
118° ACCIAIO
HSS

CODICE	ELEMENTI	DESCRIZIONE	Q.TÀ
Z02	C9410	1 mm	10
	C9415	1,5 mm	10
	C9420	2 mm	10
	C9425	2,5 mm	10
	C9430	3 mm	10
	C9432	3,2 mm	10
	C9435	3,5 mm	10
	C9440	4 mm	10
	C9442	4,2 mm	10
	C9445	4,5 mm	10
	C9448	4,8 mm	10
	C9450	5 mm	10
	C9452	5,2 mm	10
	C9455	5,5 mm	10
	C9460	6 mm	10
	C9465	6,5 mm	10
	C9470	7 mm	10
	C9475	7,5 mm	10
	C9480	8 mm	10
	C9485	8,5 mm	10
	C9490	9 mm	10
	C9495	9,5 mm	10
	C9500	10 mm	10
	C9505	10,5 mm	10
	C9510	11 mm	10
	C9515	11,5 mm	10
	C9520	12	10
	C9525	12,5	10
C9530	13	10	

Set punte da trapano

ANGOLO
118° ACCIAIO
HSS

CODICE	DESCRIZIONE	Q.TÀ
C9405	19PZ DIMENSIONI (mm): 1.0, 1.5, 2.0, 2.5, 3.0, 3.5, 4.0, 4.5, 5.0, 5.5, 6.0, 6.5, 7.0, 7.5, 8.0, 8.5, 9.0, 9.5, 10	5
C9406	25PZ DIMENSIONI (mm): 1.0, 1.5, 2.0, 2.5, 3.0, 3.5, 4.0, 4.5, 5.0, 5.5, 6.0, 6.5, 7.0, 7.5, 8.0, 8.5, 9.0, 9.5, 10.0, 10.5, 11.0, 11.5, 12.0, 12.5, 13.0	5

Sega a tazza HSS bimetallica dentata
VariabileUTILIZZO: ACCIAIO, METALLO, PLASTICA, LEGNO
MATERIALE: HSS

CODICE	DESCRIZIONE	Q.TÀ	CODICE	DESCRIZIONE	Q.TÀ
C2151	14 mm	6	C2172	64 mm	6
C2152	16 mm	6	C2173	67 mm	6
C2153	19 mm	6	C2174	68 mm	6
C2154	20 mm	6	C2175	70 mm	6
C2155	22 mm	6	C2176	73 mm	6
C2156	24 mm	6	C2177	76 mm	6
C2157	25 mm	6	C2178	83 mm	6
C2158	27 mm	6	C2179	92 mm	6
C2159	29 mm	6	C2180	95 mm	6
C2160	30 mm	6	C2181	102 mm	6
C2161	32 mm	6	C2182	105 mm	6
C2162	35 mm	6	C2183	121 mm	6
C2163	38 mm	6	C2184	127 mm	6
C2164	40 mm	6	C2185	140 mm	6
C2165	44 mm	6	C2186	152 mm	6
C2166	46 mm	6	C2187	160 mm	6
C2167	48 mm	6	C2188	180 mm	6
C2168	51 mm	6	C2189	190 mm	6
C2169	54 mm	6	C2190	200 mm	6
C2170	57 mm	6	C2191	210 mm	6
C2171	60 mm	6			

Alberi per seghe a tazza bi-metal



CODICE	DESCRIZIONE	Q.TÀ
101320400095	SW 9,5 32-152	4
101320400011	SW 11 32-210	4
101320400016	SW 16 32-210	4
101320255002	SDS-PLUS 32-152	4

Alberi per seghe a tazza bi-metal



CODICE	DESCRIZIONE	Q.TÀ
CM2195	14-30	4
CM2196	32-152	4

Penna da incisioni



CODICE	DESCRIZIONE	Q.TÀ
C5830	LUNGHEZZA 150 mm	25

Punta di centraggio

Per alberi



BI METAL

CODICE	DESCRIZIONE	Q.TÀ
CM2194	PUNTA CENTRAGGIO SEGHE TAZZA BIMETAL	1

Svasatore in titanio per ferro



NEW

ACCIAIO HSS

CODICE	DESCRIZIONE	Q.TÀ
C9260	Ø 4-12	6
C9261	Ø 4-20	6
C9262	Ø 4-32	6
C9263	Ø 4-39	6

Set svasatore in titanio per ferro



NEW

ACCIAIO HSS

CODICE	DESCRIZIONE	Q.TÀ
C9265	Ø 4-12/4-20/4-32	6

Svasatore a spirale

Per ferro



NEW

ACCIAIO
HSS

CODICE	DESCRIZIONE	Q.TÀ
C9267	Ø 4-12 mm	6
C9268	Ø 4-20 mm	6
C9269	Ø 4-32 mm	6
C9270	Ø 4-39 mm	6
C9271	Ø 4-52 mm	6

Set svasatore a spirale

Per ferro



NEW

ACCIAIO
HSS

CODICE	DESCRIZIONE	Q.TÀ
C9272	Ø 4-12 mm	6
	Ø 4-20 mm	6
	Ø 4-32 mm	6

Tagliametallo ZYA



NEW

GAMBO
6 mm ACCIAIO
HSS

CODICE	DESCRIZIONE	Q.TÀ
C8905	Ø 8X20 mm	10
C8906	Ø 10X20 mm	10
C8907	Ø 12X25 mm	10

Tagliametallo ZYA/ST



NEW

GAMBO
6 mm ACCIAIO
HSS

CODICE	DESCRIZIONE	Q.TÀ
C8908	Ø 8X20 mm	10
C8909	Ø 10X20 mm	10
C8910	Ø 12X25 mm	10

Tagliametallo WRC



NEW

CARBURO
CEMENTATO HM GAMBO
6 mm

CODICE	DESCRIZIONE	Q.TÀ
C8911	WRC Ø8X20 mm	10
C8912	WRC Ø10X20 mm	10
C8913	WRC Ø12X25 mm	10

Tagliametallo KUD



NEW

CARBURO
CEMENTATO HM GAMBO
6 mm

CODICE	DESCRIZIONE	Q.TÀ
C8914	KUD Ø8X7 mm	10
C8915	KUD Ø10X9 mm	10
C8916	KUD Ø12X11 mm	10

Tagliametallo rbf



NEW

CARBURO CEMENTATO HM
GAMBO 6 mm

CODICE	DESCRIZIONE	Q.TÀ
C8917	RBF Ø8X20 mm	10
C8918	RBF Ø10X20 mm	10
C8919	RBF Ø12X25 mm	10

Tagliametallo KEL



NEW

CARBURO CEMENTATO HM
GAMBO 6 mm

CODICE	DESCRIZIONE	Q.TÀ
C8920	KEL Ø8X22 mm	10
C8921	KEL Ø10X25 mm	10
C8922	KEL Ø12X28 mm	10

Tagliametallo SKM



NEW

CARBURO CEMENTATO HM
GAMBO 6 mm

CODICE	DESCRIZIONE	Q.TÀ
C8923	SKM Ø8X18 mm	10
C8924	SKM Ø10X20 mm	10
C8925	SKM Ø12X25 mm	10

Punta per muro calcestruzzo



CODICE	DESCRIZIONE	Q.TÀ
C9353	PUNTA PER MURO Ø3X60 mm	10
C9354	PUNTA PER MURO Ø4X75 mm	10
C9355	PUNTA PER MURO Ø5X85 mm	10
C9356	PUNTA PER MURO Ø6X100 mm	10
C9357	PUNTA PER MURO Ø6X200 mm	10
C9358	PUNTA PER MURO Ø8X110 mm	10
C9359	PUNTA PER MURO Ø8X200 mm	10
C9360	PUNTA PER MURO Ø8X400 mm	10
C9361	PUNTA PER MURO Ø10X120 mm	10
C9362	PUNTA PER MURO Ø10X200 mm	10
C9363	PUNTA PER MURO Ø10X400 mm	10
C9364	PUNTA PER MURO Ø12X120 mm	10
C9365	PUNTA PER MURO Ø12X200 mm	10
C9366	PUNTA PER MURO Ø12X400 mm	10
C9367	PUNTA PER MURO Ø4X150 mm	10
C9368	PUNTA PER MURO Ø14X400 mm	10
C9369	PUNTA PER MURO Ø16X150 mm	10
C9370	PUNTA PER MURO Ø16X400 mm	10
101204000050	LUNGA Ø5X90X150 mm	10
101204000060	LUNGA Ø6X90X150 mm	10
101204000080	LUNGA Ø8X135X200 mm	10
101204000100	LUNGA Ø10X150X200 mm	10
101204000120	LUNGA Ø12X150X200 mm	10
101204000140	LUNGA Ø14X150X200 mm	10
101204000160	LUNGA Ø16X150X200 mm	10
101204000180	LUNGA Ø18X150X200 mm	10

Set tagliametallo da 5PZ



NEW

CARBURO CEMENTATO HM
GAMBO 6 mm

CODICE	DESCRIZIONE	Q.TÀ
C8901	ZYA	1
	WRC	1
	KUD	1
	RBF	1
	SKM	1

101204000200	LUNGA Ø20X150X200 mm	10
101404000080	EXTRA-LUNGA Ø8X320X400 mm	10
101404000100	EXTRA-LUNGA Ø10X320X400 mm	10
101404000120	EXTRA-LUNGA Ø12X320X400 mm	10
101404000140	EXTRA-LUNGA Ø14X320X400 mm	10
101404000160	EXTRA-LUNGA Ø16X320X400 mm	10
101404000180	EXTRA-LUNGA Ø18X320X400 mm	10
101404000200	EXTRA-LUNGA Ø20X320X400 mm	10
101404000220	EXTRA-LUNGA Ø22X320X400 mm	10
101404000240	EXTRA-LUNGA Ø24X320X400 mm	10
101606000080	EXTRA-LUNGA Ø8X500X600 mm	10
101606000100	EXTRA-LUNGA Ø10X500X600 mm	10
101606000120	EXTRA-LUNGA Ø12X500X600 mm	10
101606000140	EXTRA-LUNGA Ø14X500X600 mm	10
101606000160	EXTRA-LUNGA Ø16X500X600 mm	10
101606000180	EXTRA-LUNGA Ø18X500X600 mm	10
101606000200	EXTRA-LUNGA Ø20X500X600 mm	10
101606000220	EXTRA-LUNGA Ø22X500X600 mm	10
101606000240	EXTRA-LUNGA Ø24X500X600 mm	10

Set punta muro



CODICE	DESCRIZIONE	Q.TÀ
C9395	5PZ Ø 4+5+6+8+10 mm	5
C9396	8PZ Ø 3+4+5+6+7+8+9+10 mm	5

C9353

Punta raptor SDS-PLUS 4 taglienti
Professionale

CODICE	DESCRIZIONE	Q.TÀ
101253040110	Ø4X50X110 mm	1
101253050110	Ø5X50X110 mm	1
101253050160	Ø5X100X160 mm	1
101253050210	Ø5X150X210 mm	1
101253050260	Ø5X200X260 mm	1
101253060110	Ø6X50X110 mm	1
101253060160	Ø6X100X160 mm	1
101253060210	Ø6X150X210 mm	1
101253080260	Ø8X200X260 mm	1
101253080450	Ø8X400X450 mm	1
101253090160	Ø9X100X160 mm	1
101253090260	Ø9X200X260 mm	1
101253100110	Ø10X50X110 mm	1
101253100160	Ø10X100X160 mm	1
101253100210	Ø10X150X210 mm	1
101253100260	Ø10X200X260 mm	1
101253100310	Ø10X250X310 mm	1
101253100360	Ø10X300X360 mm	1
101253100450	Ø10X400X450 mm	1
101253100600	Ø10X550X600 mm	1
101253120165	Ø12X100X160 mm	1
101253120215	Ø12X150X210 mm	1
101253120265	Ø12X200X260 mm	1
101253120450	Ø12X400X450 mm	1
101253120600	Ø12X550X600 mm	1
101253121000	Ø12X550X1000 mm	1
101253140160	Ø14X100X160 mm	1
101253140210	Ø14X150X210 mm	1
101253140260	Ø14X200X260 mm	1
101253140310	Ø14X250X310 mm	1
101253140450	Ø14X400X450 mm	1
101253140600	Ø14X550X600 mm	1
101253150160	Ø15X100X160 mm	1
101253160210	Ø16X150X210 mm	1
101253160260	Ø16X200X260 mm	1
101253160310	Ø16X250X310 mm	1
101253160450	Ø16X400X450 mm	1
101253160600	Ø16X550X600 mm	1
101253180210	Ø18X150X210 mm	1
101253180310	Ø18X250X310 mm	1
101253180450	Ø18X400X450 mm	1
101253200200	Ø20X150X200 mm	1
101253200300	Ø20X250X300 mm	1
101253200450	Ø20X400X450 mm	1
101253200600	Ø20X550X600 mm	1
101253220250	Ø22X200X250 mm	1
101253240260	Ø24X200X260 mm	1
101253250450	Ø25X400X450 mm	1

Punta materiali durissimi



CODICE	DESCRIZIONE	Q.TÀ
101151018040	MATERIALI DURISSIMI-GRANITO Ø4X40X75 mm	10
101151018050	MATERIALI DURISSIMI-GRANITO Ø5X50X85 mm	10
101151018060	MATERIALI DURISSIMI-GRANITO Ø6X60X100 mm	10
101151018080	MATERIALI DURISSIMI-GRANITO Ø8X80X120 mm	10
101151018100	MATERIALI DURISSIMI-GRANITO Ø10X80X120 mm	10
101151018120	MATERIALI DURISSIMI-GRANITO Ø12X90X150 mm	10
101151017140	MATERIALI DURISSIMI-GRANITO Ø14X100X250 mm	10

Punta per vetro



CODICE	DESCRIZIONE	Q.TÀ
101130000030	Ø3X58 mm	5
101130000040	Ø4X58 mm	5
101130000050	Ø5X58 mm	5
101130000060	Ø6X58 mm	5
101130000070	Ø7X78 mm	5
101130000080	Ø8X78 mm	5
101130000090	Ø9X98 mm	5

Punte diamantate/foretti standard



CODICE	DESCRIZIONE	Q.TÀ
C8930	Ø 6 mm	5
C8931	Ø 8 mm	5
C8932	Ø 10 mm	5
C8933	Ø 12 mm	5

Punta diamantata e fresa a tazza 50 mm



CODICE	DESCRIZIONE	Q.TÀ
101786000150	Ø16X90 mm	5
101786000180	Ø18X90 mm	5
101786000200	Ø20X90 mm	5
101786000220	Ø22X90 mm	5
101786000250	Ø25X90 mm	5
101786000280	Ø28X90 mm	5
101786000300	Ø30X90 mm	5
101786000320	Ø32X90 mm	5
101786000350	Ø35X90 mm	5
101786000400	Ø40X90 mm	5
101786000450	Ø45X90 mm	5
101786000500	Ø50X90 mm	5
101786000600	Ø60X90 mm	5
101786000650	Ø65X90 mm	5
101786000800	Ø80X90 mm	5

Svasatore



NEW



HSS

90°

CODICE	DESCRIZIONE	Q.TÀ
C8936	6,3x45x5 mm	10
C8937	8,3x50x6 mm	10
C8938	10,4x50 X6 mm	10
C8939	12,4x56x8 mm	10
C8940	16,5x60x8 mm	10
C8941	20,5x63x10 mm	10
C8942	25x67x10 mm	10
C8943	31x71x12 mm	10

Set svasatore



NEW

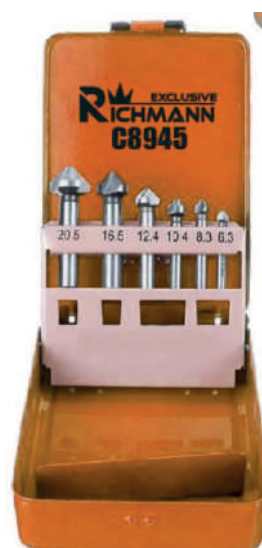

90°

HSS

CODICE	DESCRIZIONE	Q.TÀ
C8945	6,3x45x5 mm	10
	8,3x50x6 mm	
	10,4x50 X6 mm	
	12,4x56x8 mm	
	16,5x60x8 mm	
	20,5x63x10 mm	
	25x67x10 mm	
31x71x12 mm		

Adattatore per foratrice



180 mm



SDS+

CODICE	DESCRIZIONE	Q.TÀ
C8274	1 1/4"	10

Adattatore per foratrice



200 mm

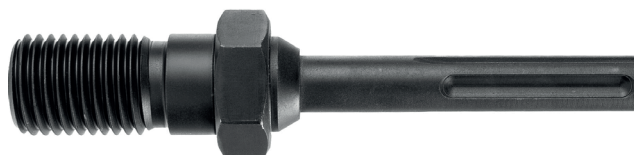

SDS MAX

CODICE	DESCRIZIONE	Q.TÀ
C8275	1 1/4" 1/2"	10

Sega a tazza



NEW

X4

CODICE	DESCRIZIONE	Q.TÀ
C8255	33 mm	10
	53 mm	
	67 mm	
	73 mm	

Fresa per legno



NEW

CODICE	DESCRIZIONE	Q.TÀ
C9971	15 mm	10
C9972	20 mm	
C9973	25 mm	
C9974	30 mm	
C9975	35 mm	
C9976	40 mm	
C9977	50 mm	

Sega a tazza bimetallica



NEW

HSS M3

CODICE	DESCRIZIONE	Q.TÀ
C2198	19 mm	10
	22 mm	
	29 mm	
	38 mm	
	44 mm	
	57 mm	
	PORTASEGA A TAZZA BIMETALLICA 14-30 mm	
PORTASEGA A TAZZA BIMETALLICA 32-152 mm		
	ADATTATORE	

Sega a tazza bimetallica



NEW

HSS M3

CODICE	DESCRIZIONE	Q.TÀ
C2199	19 mm	10
	20 mm	
	22 mm	
	25 mm	
	29 mm	
	32 mm	
	35 mm	
	38 mm	
	44 mm	
	51 mm	
	57 mm	
	64 mm	
	76 mm	
	PORTASEGA A TAZZA BIMETALLICA 14-30 mm	
	PORTASEGA A TAZZA BIMETALLICA 32-152 mm	

Scalpo a taglio



SDS PLUS

CODICE	DESCRIZIONE	Q.TÀ
C5841	20X250 mm SDS PLUS	1
C5842	40X250 mm SDS PLUS	1

Scalpo a punta



SDS PLUS

CODICE	DESCRIZIONE	Q.TÀ
C5840	LUNGHEZZA 250 mm SDS PLUS	1

Scalpo a punta tonda

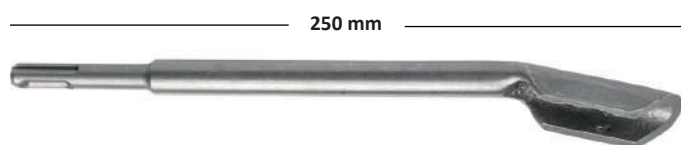

SDS PLUS

CODICE	DESCRIZIONE	Q.TÀ
C5843	20X250 mm SDS PLUS	1

Punta legno



CODICE	DESCRIZIONE	Q.TÀ
10118000030	3X33X61 mm	10
10118000040	4X43X75 mm	10
10118000050	5X52X86 mm	10
10118000060	6X57X93 mm	10
10118000070	7X65X109 mm	10
10118000080	8X70X117 mm	10
10118000090	9X70X117 mm	10
10118000100	10X80X120 mm	10
10118000110	11X94X142 mm	10
10118000120	12X101X151 mm	10
10118000130	13X101X151 mm	10
10118000140	14X108X160 mm	10
10118000150	15X114X160 mm	10
10118000160	16X120X160 mm	10
10118000180	18X130X180 mm	10
10118000200	20X140X200 mm	10
10118000220	22X140X210 mm	10
10118000240	24X140X215 mm	10
10118000260	26X145X215 mm	10
10118000280	28X145X220 mm	10
10118000300	30X145X220 mm	10

Punta combinata 3 in 1



CODICE	DESCRIZIONE	Q.TÀ
C3398	Ø6,4/4 mm	1
C3399	Ø7/5 mm	1

Set punte cobalto



5% COB ACCIAIO HSS

CODICE	DESCRIZIONE	Q.TÀ
C9801	19PZ Ø 1-10 IN 0,5 mm	5
101307501113	25PZ Ø 307/1-13 IN 0,5 mm	5

Set punte rettificate



CODICE	DESCRIZIONE	Q.TÀ
C9697	19PZ Ø 1-10X0,5 mm	5
101302501113	25PZ Ø 1-13 0,5 mm	5
101302610150	150PZ Ø 1 A 10x0.5 mm	5

Set punte da trapano

Per metalli



NEW

ACCIAIO HSS 118°

CODICE	DESCRIZIONE	Q.TÀ
C9401	13PZ, 118°, DIMENSIONI (mm): 2x44; 2,5x57; 3x63; 3,5x70; 4x75; 4,5x80; 5x86; 5,5x92; 6x93; 6,5x104; 7x111; 7,5x108; 8x117	5

Set punte speedmaster



CODICE	DESCRIZIONE	Q.TÀ
101001229301	19PZ Ø 1 A 10x0.5 mm	5
101001229450	116PCS Ø 1 A 10x0.5 mm	5

Set punte da trapano

Per metalli



NEW

ACCIAIO HSS 118°

CODICE	DESCRIZIONE	Q.TÀ
C9400	118°, DIMENSIONI (mm): 1,5; 2; 2,5; 3; 3,2; 3,5; 4; 4,5; 4,8; 5; 5,5; 6; 6,5	5

Set punte da trapano



ANGOLO 118° ACCIAIO HSS

CODICE	DESCRIZIONE	Q.TÀ
C9405	19PZ DIMENSIONI (mm): 1.0, 1.5, 2.0, 2.5, 3.0, 3.5, 4.0, 4.5, 5.0, 5.5, 6.0, 6.5, 7.0, 7.5, 8.0, 8.5, 9.0, 9.5, 10	5
C9406	25PZ DIMENSIONI (mm): 1.0, 1.5, 2.0, 2.5, 3.0, 3.5, 4.0, 4.5, 5.0, 5.5, 6.0, 6.5, 7.0, 7.5, 8.0, 8.5, 9.0, 9.5, 10.0, 10.5, 11.0, 11.5, 12.0, 12.5, 13.0	5

Valigetta in metallo punte standard



CODICE	DESCRIZIONE	Q.TÀ
101300610150	150PZ Ø 1 A 10x0.5 mm	1

Set punta 3 in 1



CODICE	DESCRIZIONE	Q.TÀ
101317500751	7PZ PUNTA 3 IN 1 + PORTAINSERTI	1

Set punta muro



CODICE	DESCRIZIONE	Q.TÀ
C9395	5PZ Ø 4+5+6+8+10 mm	5
C9396	8PZ Ø 3+4+5+6+7+8+9+10 mm	5

Set punta muro SDS



SDS PLUS

CODICE	DESCRIZIONE	Q.TÀ
C9690	SET PUNTA MURO SDS 7PZ Ø 5+6+7+8+9+10+12	5

Set seghe a tazza



CODICE	DESCRIZIONE	Q.TÀ
CM24750	HSS Ø 19-57 mm	1

Set seghe a tazza



CODICE	DESCRIZIONE	Q.TÀ
CM24751	13PZ HSS Ø 19-64 mm	1

Set frese a tazza diamantata



CODICE	DESCRIZIONE		Q.TÀ
C4848	SET FRESE A TAZZA DIAMANTATA		6
	MISURE	6, 8, 10, 20, 30, 35, 50, 68 mm	
	DIMENSIONI	180X240X90 mm	



Mandrino cremagliera



CODICE	DESCRIZIONE		Q.TÀ
C9211	MANDRINO A CREMAGLIERA IN ACCIAIO, Ø 43 mm		6
	MONTAGGIO	1/2 POLLICI	
	NUMERO GIRI	20 UNF	
	SPAZIATURA MASCELLA	1-13 mm	

Mandrino cremagliera sds



SDS PLUS

CODICE	DESCRIZIONE		Q.TÀ
C9209	MANDRINO A CREMAGLIERA, SDS, IN ACCIAIO, Ø 42 mm		6
	MONTAGGIO	1/2 POLLICI	
	NUMERO GIRI	20 UNF	
	SPAZIATURA MASCELLA	1,5-13 mm	

Mandrino autoserrante



CODICE	DESCRIZIONE		Q.TÀ
C9222	MANDRINO AUTOSERRANTE, Ø 43 mm		6
	MONTAGGIO	1/2 POLLICI	
	NUMERO GIRI	20 UNF	
	SPAZIATURA MASCELLA	2-13 mm	

Mandrino autoserrante SDS



SDS PLUS

CODICE	DESCRIZIONE		Q.TÀ
C9225	MANDRINO AUTOSERRANTE, SDS, Ø 43 mm		6
	MONTAGGIO	1/2 POLLICI	
	NUMERO GIRI	20 UNF	
	SPAZIATURA MASCELLA	2-13 mm	



BREMAK®
ABRASIVI E UTENSILI DI QUALITÀ



MIKALOR



BREMAK[®]



Fascetta a due orecchie

MIKALOR

MATERIALE
ST4 S/DIN 1624RIVESTIMENTO
ZINCATO BIANCO CR3RESISTENZA ALLA CORROSIONE
72 ORE (ASTM B-117)

CODICE	DESCRIZIONE	Q.TÀ
10503012101	5-7 ZB W1	2000
10503012110	7-9 ZB W1	1000
10503012128	9-11 ZB W1	1000
10503012099	10-12 ZB W1	500
10503012136	11-13 ZB W1	500
10503012144	13-15 ZB W1	500
10503012152	14-17 ZB W1	500
10503012160	15-18 ZB W1	500
10503012179	17-20 ZB W1	250
10503012187	18-21 ZB W1	250
10503012195	20-23 ZB W1	250
10503012208	22-25 ZB W1	200
10503012216	23-27 ZB W1	200
10503012224	25-28 ZB W1	200
10503012232	28-31 ZB W1	100
10503012240	31-34 ZB W1	100
10503012259	34-37 ZB W1	100
10503012267	37-40 ZB W1	100
10503012275	40-43 ZB W1	75
10503012283	43-46 ZB W1	75

Fascetta bifilare elastica

MIKALOR

MATERIALE
DIN 17223-BRIVESTIMENTO
ZINCATO BIANCO CR3RESISTENZA ALLA CORROSIONE
72 ORE (ASTM B-117)

CODICE	DESCRIZIONE	Q.TÀ
10502016012	7,3-7,8 W1	1000
10502016020	7,8-8,3 W1	1000
10502016039	8,3-8,8 W1	1000
10502016047	8,8-9,3 W1	1000
10502016055	9,3-9,9 W1	1000
10502016063	9,8-10,4 W1	1000
10502016080	11-11,6 W1	1000
10502016098	11,6-12,3 W1	1000
10502016071	10,4-11 W1	1000
10502016100	12,1-13,1 W1	500
10502016119	12,9-13,6 W1	500
10502016127	13,6-14,4 W1	500
10502016135	14,4-15,1 W1	500
10502016143	14,8-15,9 W1	500
10502016151	15,9-16,8 W1	500
10502016160	16,8-17,7 W1	500
10502016178	17,7-18,7 W1	500
10502016186	18,7-19,6 W1	500
10502016194	19,6-20,6 W1	500
10502016290	29,3-30,9 W1	500

Fascetta w1 ad una orecchia con anello interno inox

MIKALOR

MATERIALE
DIN 1624 AISI 301RIVESTIMENTO
ZINCATO BIANCO CR3 INOXRESISTENZA ALLA CORROSIONE
72 ORE (ASTM B-117)

CODICE	DESCRIZIONE	Q.TÀ
10503011009	7,5-8,5	2000
10503011010	8,0-9,5	1000
10503011029	9,0-10,5	1000
10503011037	10,0-11,5	500
10503011045	10,5-12,5	500
10503011053	11,5-13,3	500
10503011061	13,0-15,3	500
10503011070	15,0-17,3	500

Fascetta w4 ad una orecchia con anello interno inox

MIKALOR

MATERIALE
DIN 1624 AISI 301RIVESTIMENTO
ZINCATO BIANCO CR3 INOXRESISTENZA ALLA CORROSIONE
72 ORE (ASTM B-117)

CODICE	DESCRIZIONE	Q.TÀ
10523012300	7,5-8,5	2000
10523012319	8,2-9,5	1000
10523012327	9,0-10,5	1000
10523012335	10,0-11,5	1000
10523012343	10,5-12,5	500
10523012351	11,5-13,5	500
10523012360	12,5-14,5	500
10523012378	13,0-15,3	500
10523012386	14,0-16,3	250
10523012394	15,0-17,3	250
10523012407	16,0-18,3	250
10523012415	17,0-19,3	250

Pinza fascette orecchio montaggio frontale e laterale

MIKALOR



CODICE	DESCRIZIONE	Q.TÀ
10503011088	PINZA FASCETTE ORECCHIO MONTAGGIO FRONTALE	6
10503011096	PINZA FASCETTE ORECCHIO MONTAGGIO LATERALE	6

Nastro perforato + testine

MIKALOR



CODICE	DESCRIZIONE	Q.TÀ
10503035101	BLISTER 3 METRI NASTRO PERFORATO 8 mmS + 8 TESTINE W2	10
10503035111	25 METRI NASTRO PERFORATO 8 mmS W2	10
10503035121	50 TESTINE PER NASTRO PERFORATO 8 mmS W2	10
10503035301	BLISTER 3 METRI NASTRO PERFORATO 8 mmS + 8 TESTINE W4	10
10503035311	25 METRI NASTRO PERFORATO 8 mmS W4	10
10503035321	50 TESTINE PER NASTRO PERFORATO 8 mmS W4	10
10503035601	BLISTER 3 METRI NASTRO PERFORATO 14 mmS + 6 TESTINE W2	10
10503035611	25 METRI NASTRO PERFORATO 14 mmS W2	10
10503035621	50 TESTINE PER NASTRO PERFORATO 14 mmS W2	10
10503035801	BLISTER 3 METRI NASTRO PERFORATO 14 mmS + 6 TESTINE W4	10
10503035811	25 METRI NASTRO PERFORATO 14 mmS W4	10
10503035821	50 TESTINE PER NASTRO PERFORATO 14 mmS W4	10

Stringitubo a nastro inox 4,5

MIKALOR



MATERIALE
AISI-304

RIVESTIMENTO
ACCIAIO INOX

RESISTENZA ALLA CORROSIONE
400 ORE (ASTM B-117)

CODICE	DESCRIZIONE	Q.TÀ
10503002001	4,5X33 L130	100
10503002002	4,5X50 L200	100
10503002003	4,5X76 L300	100
10503002004	4,5X102 L370	100
10503002005	4,5X156 L520	100
10503002006	4,5X207 L680	100
10503002007	4,5X245 L840	100

Stringitubo a nastro inox 7,94

MIKALOR



MATERIALE
AISI-304

RIVESTIMENTO
ACCIAIO INOX

RESISTENZA ALLA CORROSIONE
400 ORE (ASTM B-117)

CODICE	DESCRIZIONE	Q.TÀ
10503002008	7,94X50 L200	100
10503002009	7,94X76 L300	100
10503002010	7,94X102 L370	100
10503002011	7,94X135 L450	100
10503002012	7,94X150 L500	100
10503002013	7,94X207 L680	100
10503002014	7,94X312 L1020	100

Collare breclamp con profilo gomma W1 passacavo

MIKALOR



MATERIALE
DIN 1.0529

RIVESTIMENTO
PROFILO EPDM

RESISTENZA ALLA TEMPERATURA
- 40 + 120 °C

CODICE	DESCRIZIONE	Q.TÀ
10503004664	W1 NASTRO 15 mm FORO 6,4 mm DA 6	200
10503004680	W1 NASTRO 15 mm FORO 6,4 mm DA 8	200
10503004701	W1 NASTRO 15 mm FORO 6,4 mm DA 10	200
10503004728	W1 NASTRO 15 mm FORO 6,4 mm DA 12	200
10503004744	W1 NASTRO 15 mm FORO 6,4 mm DA 14	200
10503004760	W1 NASTRO 15 mm FORO 6,4 mm DA 16	200
10503004787	W1 NASTRO 15 mm FORO 6,4 mm DA 18	200
10503004808	W1 NASTRO 15 mm FORO 6,4 mm DA 20	200
10503004824	W1 NASTRO 15 mm FORO 6,4 mm DA 22	100
10503004859	W1 NASTRO 15 mm FORO 6,4 mm DA 24	100
10503004865	W1 NASTRO 15 mm FORO 6,4 mm DA 25	100
10503004867	W1 NASTRO 15 mm FORO 6,4 mm DA 26	100
10503004883	W1 NASTRO 15 mm FORO 6,4 mm DA 28	100
10503004904	W1 NASTRO 15 mm FORO 6,4 mm DA 30	100
10503004920	W1 NASTRO 15 mm FORO 6,4 mm DA 32	100
10503004947	W1 NASTRO 15 mm FORO 6,4 mm DA 34	100
10503004971	W1 NASTRO 15 mm FORO 6,4 mm DA 36	100
10503004980	W1 NASTRO 15 mm FORO 6,4 mm DA 38	100
10503005000	W1 NASTRO 15 mm FORO 6,4 mm DA 40	100
10503005005	W1 NASTRO 15 mm FORO 6,4 mm DA 46	100

Pistola montaggio fascette e stringitubo

MIKALOR



CODICE	DESCRIZIONE	Q.TÀ
10503002015	PISTOLA MONTAGGIO FASCETTA STRINGITUBO	1

Fascetta asfa 5 mm W2

MIKALOR



MATERIALE
X8 Cr17 (AISI 430)

RIVESTIMENTO
ACCIAIO INOX

RESISTENZA ALLA CORROSIONE
72 ORE (ASTM B-117)

CODICE	DESCRIZIONE	Q.TÀ
10503016410	5 mm 11-19 W2	100
10503016401	5 mm 6-11 W2	100

Collarino mini breclamp W1

MIKALOR



CODICE	DESCRIZIONE	Q.TÀ
105FMW17-9	W1 7- 9	100
105FMW18-10	W1 8- 10	100
105FMW19-11	W1 9- 11	100
105FMW110-12	W1 10- 12	100
105FMW111-13	W1 11- 13	100
105FMW112-14	W1 12- 14	100
105FMW113-15	W1 13- 15	100
105FMW114-16	W1 14- 16	100
105FMW115-17	W1 15- 17	100
105FMW116-18	W1 16- 18	100
105FMW117-19	W1 17- 19	100
105FMW118-20	W1 18- 20	100
105FMW119-21	W1 19- 21	100
105FMW120-22	W1 20- 22	100
105FMW121-23	W1 21- 23	100
105FMW122-24	W1 22- 24	100
105FMW123-25	W1 23- 25	100
105FMW125-27	W1 25- 27	100
105FMW146-48	W1 46- 48	50
105FMW160-62	W1 60- 62	50

Collarino mini breclamp W4

MIKALOR



CODICE	DESCRIZIONE	Q.TÀ
105FMW47-9	W4 7- 9	100
105FMW48-10	W4 8- 10	100
105FMW49-11	W4 9- 11	100
105FMW410-12	W4 10- 12	100
105FMW411-13	W4 11- 13	100
105FMW412-14	W4 12- 14	100
105FMW413-15	W4 13- 15	100
105FMW414-16	W4 14- 16	100
105FMW415-17	W4 15- 17	100
105FMW416-18	W4 16- 18	100
105FMW417-19	W4 17- 19	100
105FMW418-20	W4 18- 20	100
105FMW419-21	W4 19- 21	100
105FMW420-22	W4 20- 22	100
105FMW421-23	W4 21- 23	100
105FMW422-24	W4 22- 24	100
105FMW423-25	W4 23- 25	100
105FMW425-27	W4 25- 27	100

Giravite flessibile per fascette da 7 mm

MIKALOR



CODICE	DESCRIZIONE	Q.TÀ
10503091036	GIRAVITE PER FASCETTE DA 7 mm	6

Espositore a muro vuoto ASFA-L W2

MIKALOR

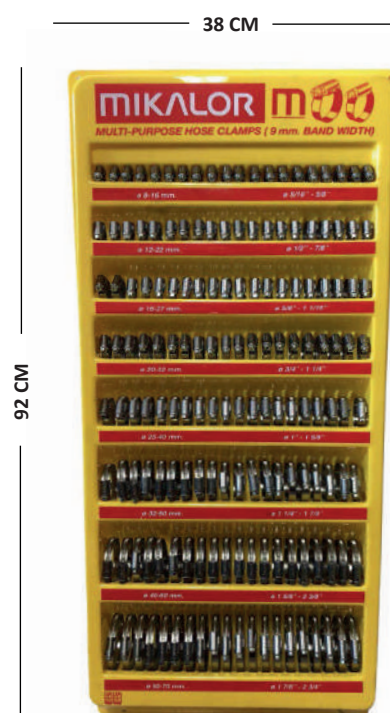

CODICE	DESCRIZIONE	Q.TÀ
10502500052C	ESPOSITORE A MURO VUOTO ASFA-L W2	6

Fascetta ASFA 9mm W2

MIKALOR



MATERIALE
GALVANIZZATO (EN 1.0935)

RIVESTIMENTO
GALVANIZZATO

RESISTENZA ALLA CORROSIONE
144 ORE (ASTM B-117)

CODICE	DESCRIZIONE	Q.TÀ
10503016508	9 mm 8-12 W2	200
10503016516	9 mm 8-16 W2	200
10503016524	9 mm 12-22 W2	200
10503016523	9 mm 16-27 W2	200
10503016540	9 mm 20-32 W2	200
10503016559	9 mm 25-40 W2	100
10503016567	9 mm 30-45 W2	100
10503016575	9 mm 32-50 W2	100
10503016583	9 mm 40-60 W2	100
10503016591	9 mm 50-70 W2	100
10503016604	9 mm 60-80 W2	100
10503016612	9 mm 70-90 W2	50
10503016620	9 mm 80-100 W2	50
10503016639	9 mm 90-110 W2	25
10503016647	9 mm 100-120 W2	25
10503016655	9 mm 110-130 W2	25
10503016663	9 mm 120-140 W2	25
10503016671	9 mm 120-140 W2	25
10503016680	9 mm 130-150 W2	25
10503016680	9 mm 140-160 W2	25

Fascetta ASFA 9mm W4 INOX

MIKALOR



MATERIALE
GALVANIZZATO (EN 1.0935)

RIVESTIMENTO
GALVANIZZATO

RESISTENZA ALLA CORROSIONE
144 ORE (ASTM B-117)

CODICE	DESCRIZIONE	Q.TÀ
10503014019	9 mm 8-12 W4	200
10503014027	9 mm 12-22 W4 INOX	200
10503014035	9 mm 16-27 W4 INOX	200
10503014043	9 mm 20-32 W4 INOX	200
10503014051	9 mm 25-40 W4 INOX	100
10503014060	9 mm 30-45 W4 INOX	100
10503014078	9 mm 32-50 W4 INOX	100
10503014086	9 mm 40-60 W4 INOX	100
10503014094	9 mm 50-70 W4 INOX	100
10503014107	9 mm 60-80 W4 INOX	100
10503014115	9 mm 70-90 W4 INOX	50
10503014123	9 mm 80-100 W4 INOX	50
10503014140	9 mm 90-110 W4 INOX	25
10503014158	9 mm 100-120W4 INOX	25
10503014166	9 mm 110-130 W4 INOX	25
10503014174	9 mm 120-140 W4 INOX	25
10503014182	9 mm 130-150 W4 INOX	25
10503014190	9 mm 140-160 W4 INOX	25

Fascetta ASFA 12mm W2

MIKALOR



MATERIALE
ACCIAIO INOX (AISI 430)

RIVESTIMENTO
ACCIAIO INOX

RESISTENZA ALLA CORROSIONE
72 ORE (ASTM B-117)

CODICE	DESCRIZIONE	Q.TÀ
10503017017	12 mm 16-27 W2	50
10503017025	12 mm 20-32 W2	50
10503017033	12 mm 25-40 W2	50
10503017009	12 mm 30-45 W2	50
10503017041	12 mm 32-50 W2	50
10503017050	12 mm 40-60 W2	50
10503017068	12 mm 50-70 W2	50
10503017076	12 mm 60-80 W2	50
10503017084	12 mm 70-90 W2	50
10503017092	12 mm 80-100 W2	25
10503017105	12 mm 90-110 W2	25
10503017113	12 mm 100-120 W2	25
10503017121	12 mm 110-130 W2	25
10503017130	12 mm 120-140 W2	25
10503017148	12 mm 130-150 W2	25
10503017156	12 mm 140-160 W2	25
10503017164	12 mm 150-170 W2	25
10503017172	12 mm 160-180 W2	10
10503017180	12 mm 170-190 W2	10
10503017199	12 mm 180-200 W2	10
10503017201	12 mm 190-210 W2	10
10503017210	12 mm 200-220 W2	10
10503017228	12 mm 210-230 W2	10
10503017236	12 mm 220-240 W2	10

Fascetta ASFA 12mm W4 inox

MIKALOR



MATERIALE
ACCIAIO INOX (AISI 430)

RIVESTIMENTO
ACCIAIO INOX

RESISTENZA ALLA CORROSIONE
72 ORE (ASTM B-117)

CODICE	DESCRIZIONE	Q.TÀ
10503014730	12 mm 16-27 W4 INOX	50
10503014510	12 mm 20-32 W4 INOX	50
10503014529	12 mm 25-40 W4 INOX	50
10503014748	12 mm 30-45 W4 INOX	50
10503014537	12 mm 32-50 W4 INOX	50
10503014545	12 mm 40-60 W4 INOX	50
10503014553	12 mm 50-70 W4 INOX	50
10503014561	12 mm 60-80 W4 INOX	50
10503014570	12 mm 70-90 W4 INOX	50
10503014588	12 mm 80-100 W4 INOX	25
10503014596	12 mm 90-110 W4 INOX	25
10503014609	12 mm 100-120 W4 INOX	25
10503014617	12 mm 110-130 W4 INOX	25
10503014625	12 mm 120-140 W4 INOX	25
10503014633	12 mm 130-150 W4 INOX	25
10503014641	12 mm 140-160 W4 INOX	25
10503014650	12 mm 150-170 W4 INOX	25
10503014668	12 mm 160-180 W4 INOX	25
10503014676	12 mm 170-190 W4 INOX	10
10503014684	12 mm 180-200 W4 INOX	10
10503014692	12 mm 190-210 W4 INOX	10
10503014705	12 mm 200-220 W4 INOX	10
10503014713	12 mm 210-230 W4 INOX	10
10503014721	12 mm 220-240 W4 INOX	10

Collare a bullone super W1

MIKALOR

MATERIALE

FASCIA: ACCIAIO SEMI DUTTILE (F111)**VITE: ACCIAIO QST 36-3 (DIN 10.213)****BOSSOLI: ACCIAIO (DIN 1.0333)**

RIVESTIMENTO

ZINCATO BIANCO CR3

RESISTENZA ALLA CORROSIONE

72 ORE (ASTM B-117)

CODICE	DESCRIZIONE	Q.TÀ
10503018263	17-19 W1	50
10503018271	20-22 W1	50
10503018280	23-25 W1	50
10503018298	26-28 W1	50
10503018300	29-31 W1	50
10503018319	32-35 W1	50
10503018327	36-39 W1	50
10503018335	40-43 W1	50
10503018010	44-47 W1	50
10503018028	48-51 W1	50
10503018036	52-55 W1	25
10503018044	56-59 W1	25
10503018052	60-63 W1	25
10503018060	64-67 W1	25
10503018079	68-73 W1	25
10503018087	74-79 W1	25
10503018095	80-85 W1	25
10503018108	86-91 W1	25
10503018116	92-97 W1	25
10503018124	98-103 W1	25
10503018132	104-112 W1	25
10503018140	113-121 W1	25
10503018159	122-130 W1	25
10503018167	131-139 W1	10
10503018175	140-148 W1	10
10503018183	149-161 W1	10
10503018191	162-174 W1	10
10503018204	175-187 W1	10
10503018212	188-200 W1	10
10503018220	201-213 W1	10
10503018239	214-226 W1	10
10503018247	227-239 W1	10
10503018255	240-252 W1	10
10503018260	265-278 W1	10

Collare bullone supra W4 inox

MIKALOR

MATERIALE

FASCIA: ACCIAIO SEMI DUTTILE (F111)**VITE: ACCIAIO QST 36-3 (DIN 10.213)****BOSSOLI: ACCIAIO (DIN 1.0333)**

RIVESTIMENTO

ZINCATO BIANCO CR3

RESISTENZA ALLA CORROSIONE

72 ORE (ASTM B-117)

CODICE	DESCRIZIONE	Q.TÀ
10503013016	17-19 W4 INOX	50
10503013024	19-21 W4 INOX	50
10503013032	21-23 W4 INOX	50
10503013040	23-25 W4 INOX	50
10503013059	25-27 W4 INOX	50
10503013067	27-29 W4 INOX	50
10503013075	29-31 W4 INOX	50
10503013083	31-34 W4 INOX	50
10503013091	34-37 W4 INOX	50
10503013104	37-40 W4 INOX	50
10503013112	40-43 W4 INOX	50
10503013120	43-47 W4 INOX	50
10503013139	47-51 W4 INOX	50
10503013147	51-55 W4 INOX	25
10503013155	55-59 W4 INOX	25
10503013163	59-63 W4 INOX	25
10503013171	63-68 W4 INOX	25
10503013180	68-73 W4 INOX	25
10503013198	73-79 W4 INOX	25
10503013200	79-85 W4 INOX	25
10503013219	85-91 W4 INOX	25
10503013227	91-97 W4 INOX	25
10503013235	97-104 W4 INOX	25
10503013243	104-112 W4 INOX	25
10503013251	112-121 W4 INOX	25
10503013260	121-130 W4 INOX	25
10503013278	130-140 W4 INOX	10
10503013286	140-150 W4 INOX	10
10503013294	150-162 W4 INOX	10
10503013307	162-174 W4 INOX	10
10503013315	174-187 W4 INOX	10
10503013323	187-200 W4 INOX	10
10503013331	200-213 W4 INOX	10
10503013340	213-226 W4 INOX	10
10503013358	226-239 W4 INOX	10
10503013366	239-252 W4 INOX	10

Fascetta in poliammide 6.6



CODICE	DESCRIZIONE	Q.TÀ
1049135	3,6x140 VERDE (CONFEZIONE DA 100PZ)	10
1049155	3,6x200 VERDE (CONFEZIONE DA 100PZ)	10
1049295	4,8x370 VERDE (CONFEZIONE DA 100PZ)	10

Fascetta in poliammide 6.6



CODICE	DESCRIZIONE	Q.TÀ
1049133	3,6x140 ROSSO (CONFEZIONE DA 100PZ)	10
1049153	3,6x200 ROSSO (CONFEZIONE DA 100PZ)	10
1049293	4,8x370 ROSSO (CONFEZIONE DA 100PZ)	10

Fascetta in poliammide 6.6



CODICE	DESCRIZIONE	Q.TÀ
1049050C	2,5x100 BIANCA (CONFEZIONE DA 100PZ)	50
1049070C	2,5x140 BIANCA (CONFEZIONE DA 100PZ)	50
1049080C	2,5x200 BIANCA (CONFEZIONE DA 100PZ)	50
1049130C	3,6x140 BIANCA (CONFEZIONE DA 100PZ)	50
1049150C	3,6x200 BIANCA (CONFEZIONE DA 100PZ)	50
1049152C	3,6x250 BIANCA (CONFEZIONE DA 100PZ)	50
1049160C	3,6x300 BIANCA (CONFEZIONE DA 100PZ)	50
1049170C	3,6x370 BIANCA (CONFEZIONE DA 100PZ)	50
1049240C	4,8x160 BIANCA (CONFEZIONE DA 100PZ)	50
1049260C	4,8x200 BIANCA (CONFEZIONE DA 100PZ)	50
1049270C	4,8x250 BIANCA (CONFEZIONE DA 100PZ)	25
1049280C	4,8x300 BIANCA (CONFEZIONE DA 100PZ)	25
1049290C	4,8x370 BIANCA (CONFEZIONE DA 100PZ)	25
1049420C	7,6x250 BIANCA (CONFEZIONE DA 100PZ)	25
1049430C	7,6x300 BIANCA (CONFEZIONE DA 100PZ)	25
1049440C	7,6x370 BIANCA (CONFEZIONE DA 100PZ)	25
1049450C	7,6x450 BIANCA (CONFEZIONE DA 100PZ)	25
1049460C	7,6x540 BIANCA (CONFEZIONE DA 100PZ)	25
1049520C	9,0x780 BIANCA (CONFEZIONE DA 100PZ)	25

Fascetta in poliammide 6.6



CODICE	DESCRIZIONE	Q.TÀ
1049051C	2,5x100 NERO (CONFEZIONE DA 100PZ)	50
1049071C	2,5x140 NERO (CONFEZIONE DA 100PZ)	50
1049081C	2,5x200 NERO (CONFEZIONE DA 100PZ)	50
1049131C	3,6x140 NERO (CONFEZIONE DA 100PZ)	50
1049151C	3,6x200 NERO (CONFEZIONE DA 100PZ)	50
1049153C	3,6x250 NERO (CONFEZIONE DA 100PZ)	50
1049161C	3,6x300 NERO (CONFEZIONE DA 100PZ)	50
1049171C	3,6x370 NERO (CONFEZIONE DA 100PZ)	50
1049241C	4,8x160 NERO (CONFEZIONE DA 100PZ)	50
1049261C	4,8x200 NERO (CONFEZIONE DA 100PZ)	50
1049271C	4,8x250 NERO (CONFEZIONE DA 100PZ)	25
1049281C	4,8x300 NERO (CONFEZIONE DA 100PZ)	25
1049291C	4,8x370 NERO (CONFEZIONE DA 100PZ)	25
1049421C	7,6x250 NERO (CONFEZIONE DA 100PZ)	25
1049431C	7,6x300 NERO (CONFEZIONE DA 100PZ)	25
1049441C	7,6x370 NERO (CONFEZIONE DA 100PZ)	25
1049451C	7,6x450 NERO (CONFEZIONE DA 100PZ)	25
1049461C	7,6x540 NERO (CONFEZIONE DA 100PZ)	25
1049521C	9,0x780 NERO (CONFEZIONE DA 100PZ)	25

Basetta adesiva



CODICE	DESCRIZIONE	Q.TÀ
104619X19	19X19 (100PZ) FASCETTA MAX 3,6	1
104628X28	28X28 (100PZ) FASCETTA MAX 4,8	1
104819X19	19X19 (100PZ) FASCETTA MAX 3,6	1
104828X28	28X28 (100PZ) FASCETTA MAX 4,8	1

Tassello per fascette



CODICE	DESCRIZIONE	Q.TÀ
1049769	NERO 6x40	1
1049770	BIANCO 6x40	1
1049771	NERO 8x40	1
1049772	BIANCO 8x40	1

Supporto a stella con fissaggio a vite



CODICE	DESCRIZIONE	Q.TÀ
1046220X162	BIANCA 22X16 mm (100PZ)	50
1048180X129	NERO 22X16 mm (100PZ)	50

Pistola chiusura fascette nylon 2,2-4,8



CODICE	DESCRIZIONE	Q.TÀ
TO-73875	PISTOLA CHIUSURA FASCETTE NYLON 2,2-4,8	5

Rondella di sicurezza DIN 6799 benzing



CODICE	DESCRIZIONE	Q.TÀ
10501110028	Ø 1,2 mm	3000
10501110036	Ø 1,5 mm	10000
10501110044	Ø 1,9 mm	10000
10501110052	Ø 2,3 mm	5000
10501110060	Ø 3,2 mm	5000
10501110079	Ø 4 mm	2500
10501110087	Ø 5 mm	1250
10501110095	Ø 6 mm	2500
10501110108	Ø 7 mm	2500
10501110116	Ø 8 mm	2000
10501110124	Ø 9 mm	1000
10501110132	Ø 10 mm	750
10501110140	Ø 12 mm	1000
10501110159	Ø 15 mm	500
10501110167	Ø 19 mm	250
10501110175	Ø 24 mm	200

Anello rapido circolare per alberi SRM



CODICE	DESCRIZIONE	Q.TÀ
10502110370	Ø 2 mm	200
10502110257	Ø 3 mm	200
10502110388	Ø 4 mm	200
10502110396	Ø 5 mm	200
10502110409	Ø 6 mm	200
10502110417	Ø 7 mm	200
10502110425	Ø 8 mm	200
10502110433	Ø 9 mm	200
10502110281	Ø 10 mm	200
10502110441	Ø 12 mm	100
10502110450	Ø 14 mm	100
10502110451	Ø 16 mm	100
10502110452	Ø 18 mm	50
10502110453	Ø 20 mm	50
10502110454	Ø 25 mm	50

Anelli fori DIN 472 – seeger interno



INTERNO

CODICE	DESCRIZIONE	Q.TÀ
10501095017	Ø 8 mm	2500
10501095025	Ø 9 mm	4000
10501095033	Ø 10 mm	3000
10501095050	Ø 12 mm	1000
10501095068	Ø 13 mm	2500
10501095076	Ø 14 mm	1000
10501095084	Ø 15 mm	2500
10501095092	Ø 16 mm	2000
10501095105	Ø 17 mm	2000
10501095121	Ø 19 mm	200
10501095130	Ø 20 mm	200
10501095148	Ø 21 mm	200
10501095156	Ø 22 mm	200
10501095172	Ø 24 mm	170
10501095199	Ø 26 mm	170
10501095210	Ø 28 mm	170
10501095228	Ø 30 mm	170
10501095244	Ø 32 mm	170
10501095260	Ø 35 mm	125
10501095308	Ø 40 mm	100
10501095316	Ø 42 mm	100
10501095340	Ø 47 mm	100
10501095375	Ø 52 mm	100
10501095412	Ø 58 mm	100
10501095420	Ø 60 mm	100

Anelli alberi DIN 471 seeger esterno

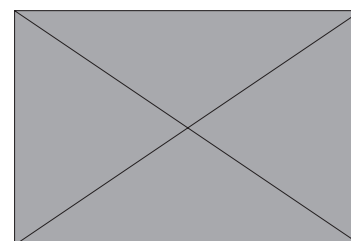

ESTERNO

CODICE	DESCRIZIONE	Q.TÀ
10501090030	Ø 5 mm	2500
10501090064	Ø 8 mm	4000
10501090072	Ø 9 mm	2000
10501090080	Ø 10 mm	1500
10501090099	Ø 11 mm	1500
10501090099	Ø 11 mm	1000
10501090101	Ø 12 mm	1000
10501090128	Ø 13 mm	1000
10501090136	Ø 14 mm	1000
10501090144	Ø 15 mm	1000
10501090152	Ø 16 mm	1000
10501090160	Ø 17 mm	1000
10501090179	Ø 18 mm	1000
10501090187	Ø 19 mm	1000
10501090195	Ø 20 mm	1000
10501090208	Ø 21 mm	1000
10501090216	Ø 22 mm	500
10501090232	Ø 24 mm	500
10501090240	Ø 25 mm	500
10501090267	Ø 28 mm	250
10501090283	Ø 30 mm	250
10501090320	Ø 35 mm	250
10501090347	Ø 38 mm	100
10501090355	Ø 40 mm	100
10501090363	Ø 42 mm	100
10501090371	Ø 45 mm	100

Spina elastica DIN 1481



CODICE	DESCRIZIONE	Q.TÀ
10501100155	Ø 2X10 mm	1000
10501100227	Ø 2X24 mm	1000
10501100446	Ø 3X8 mm	1000
10501100462	Ø 3X12 mm	1000
10501100500	Ø 3X20 mm	1000
10501103110	Ø 3X50 mm	1000
10501100649	Ø 4X12 mm	1000
10501100681	Ø 4X20 mm	1000
10501100710	Ø 4X26 mm	1000
10501100761	Ø 4X40 mm	1000
10501100825	Ø 5X10 mm	1000
10501100876	Ø 5X20 mm	1000
10501100921	Ø 5X30 mm	1000
10501100972	Ø 5X50 mm	1000
10501101051	Ø 6X12 mm	1000
10501101115	Ø 6X24 mm	1000
10501101174	Ø 6X40 mm	500
10501101350	Ø 8X20 mm	500
10501101422	Ø 8X36 mm	500
10501101473	Ø 8X60 mm	250
10501101641	Ø 10X24 mm	250
10501101705	Ø 10X40 mm	250
10501101748	Ø 10X60 mm	100
10501101967	Ø 12X30 mm	100
10501102054	Ø 12X70 mm	100

Dado a farfalla



CODICE	DESCRIZIONE	Q.TÀ
10502085015	M 3	500
10502085023	M.4	500
10502085031	M 5	200
10502085040	M 6	200
10502085066	M 8	100
10502085074	M 10	100
10502085082	M 12	50
10502085154	W 1/8	500
10502085162	W 5/32	500
10502085170	W 3/16	200
10502085189	W 1/4	200
10502085197	W 5/16	100
10502085200	W 3/8	100
10502085218	W 1/2	50

Vite a farfalla



CODICE	DESCRIZIONE	Q.TÀ
10503120033	M3x10	200
10503120068	M3x16	200
10503120092	M4x10	200
10503120113	M4x14	200
10503120130	M4x20	200
10503120164	M5x12	200
10503120180	M5x16	200
10503120201	M5x25	200
10503120236	M6x14	200
10503120252	M6x20	200

Assortimento oring



R-01 3x1,5 - 20pz.	R-17 20x3,5-10pz
R-02 4,4x2 - 20pz.	R-18 22x3,5-10pz
R-03 5x2,5 - 18pz.	R-19 23,5x3,5-10
R-04 7x1,5 - 23pz.	R-20 25x3,5-10pz
R-05 10x1,5 - 23pz.	R-21 26,5x3,5-10
R-06 13x1,5 - 23pz.	R-22 28x3,5-10pz
R-07 10x2,5 - 14pz.	R-23 30x3,5-10pz
R-08 11x2,5 - 13pz.	R-24 31x3,5-10pz
R-09 13x2,5 - 14pz.	R-25 33x3,5-10pz
R-10 14x2,5 - 13pz.	R-26 34,5x3,5-10
R-11 16x2,5 - 14pz.	R-27 36x3,5-10pz
R-12 18x2,5 - 14pz.	R-28 38x3,5-10pz
R-13 19x2,5 - 13pz.	R-29 41x3,5-10pz
R-14 21x1,5 - 14pz.	R-30 44x3,5-10pz
R-15 22x1,5 - 13pz.	R-31 47x3,5-10pz
R-16 18x3,5 - 10pz.	R-32 50x3,5-10pz

CODICE	DESCRIZIONE	Q.TÀ
C0411	ASSORTIMENTO ORING 419PZ	6

Assortimento oring per aria condizionata



20 pz. - 5,29x1,78	15 pz. - 11x2
20 pz. - 6,07x1,78	15 pz. - 11x1,78
20 pz. - 6,8x1,9	10 pz. - 13,9x1,78
20 pz. - 7,65x1,78	15 pz. - 12,95x2
20 pz. - 7,8x1,9	10 pz. - 10x2
20 pz. - 7,8x1,9	10 pz. - 14x2
20 pz. - 8,8x1,9	10 pz. - 17x2
10 pz. - 10x2	10 pz. - 17x1,78
15 pz. - 10,77x2,62	10 pz. - 17x3,53

CODICE	DESCRIZIONE	Q.TÀ
C0412	ASSORTIMENTO ORING 270PZ	6

Assortimento guarnizioni igienico-sanitari



GUARNIZIONE GO mmA	
5 PZ. - 3/8"	8X18X4 mm
5 PZ. - 3/8"	10,5X14X4 mm
10 PZ. - 1/2"	4X16X4 mm
10 PZ. - 1/2"	4X17X4 mm
5 PZ. - 1/2"	8X14X4 mm
10 PZ. - 3/4"	8X18X4 mm
5 PZ. - 3/4"	15X24X3 mm

KLINGERIT	
10 PZ. - 1/2"	12X17,5X1 mm
10 PZ. - 1/2"	17X24,5X2 mm
3 PZ. - 1,1/4"	30X39X1 mm
3 PZ. - 1,1/2"	27X38X2 mm

GUARNIZIONE FIBRA	
10 PZ. - 3/8"	10X13,5X2 mm
10 PZ. - 3/8"	12X17,5X1,5 mm
10 PZ. - 1/2"	17X21X1,5 mm
10 PZ. - 1/2"	17X24X1,5 mm
10 PZ. - 3/4"	20,5X25X1,5 mm
5 PZ. - 1"	27X33X1,5 mm

CODICE	DESCRIZIONE	Q.TÀ
C0422	GUARNIZIONI IGENICO-SANITARI 141 PZ	6

Assortimento micro fusibile



20 PZ. - 5A
20 PZ. - 10A
20 PZ. - 15A
20 PZ. - 20A
20 PZ. - 25A
20 PZ. - 30A

CODICE	DESCRIZIONE	Q.TÀ
C0446	ASSORTIMENTO MICRO FUSIBILE 120PZ	6

Assortimento mini fusibile



20 PZ. - 5A
20 PZ. - 10A
20 PZ. - 15A
20 PZ. - 20A
20 PZ. - 25A
20 PZ. - 30A

CODICE	DESCRIZIONE	Q.TÀ
C0403	ASSORTIMENTO MINI FUSIBILE 120PZ	6

Assortimento fusibile



20 PZ.- 5A
20 PZ.- 10A
20 PZ.- 15A
20 PZ.- 20A
20 PZ.- 25A
20 PZ.- 30A

CODICE	DESCRIZIONE	Q.TÀ
C0404	ASSORTIMENTO FUSIBILE 120PZ	6

Assortimento maxi fusibile



3 PZ.- 20A
3 PZ.- 30A
3 PZ.- 40A
3 PZ.- 50A
3 PZ.- 60A
3 PZ.- 70A
3 PZ.- 80A
3 PZ.- 100A

CODICE	DESCRIZIONE	Q.TÀ
C0448	ASSORTIMENTO MAXI FUSIBILE 24PZ	6

Assortimento fusibile micro/standard/maxi



MINI	STANDARD	MAXI
5 PZ.- 3A	5 PZ.- 3A	1 PZ.- 20A
5 PZ.- 5A	5 PZ.- 5A	1 PZ.- 30A
5 PZ.- 7,5A	5 PZ.- 7,5A	1 PZ.- 40A
5 PZ.- 10A	5 PZ.- 10A	1 PZ.- 50A
5 PZ.- 15A	5 PZ.- 15A	1 PZ.- 60A
5 PZ.- 20A	5 PZ.- 20A	5 PZ.- 70A
5 PZ.- 25A	5 PZ.- 25A	1 PZ.- 80A
5 PZ.- 30A	5 PZ.- 30A	1 PZ.- 100A

CODICE	DESCRIZIONE	Q.TÀ
C0429	ASS. FUSIBILE MICRO / STANDARD / MAXI 88PZ	6

Assortimento fusibile in vetro

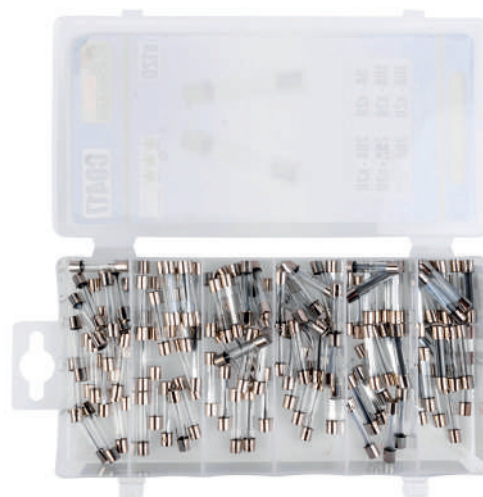

20pz.- 5A
20pz.- 10A
20pz.- 15A
20pz.- 20A
20pz.- 25A
20pz.- 30A

CODICE	DESCRIZIONE	Q.TÀ
C0417	ASSORTIMENTO FUSIBILE IN VETRO 120PZ	6

Assortimento capicorda



- | | | | |
|--|---------|--|-----------|
| | 4 szt. | | 4 szt. |
| | 5 szt. | | 10 szt. |
| | 8 szt. | | 10 szt. |
| | 12 szt. | | 4 szt. |
| | 10 szt. | | 12 szt. |
| | 10 szt. | | 18 szt. |
| | 4 szt. | | 10 szt. |
| | 5 szt. | | 2x10 szt. |
| | 4 szt. | | 10 szt. |

CODICE	DESCRIZIONE	Q.TÀ
C0421	ASSORTIMENTO CAPICORDA 160PZ	6

Assortimento capicorda



- | | | | |
|--|--------|--|--------|
| | 25szt. | | 30szt. |
| | 30szt. | | 25szt. |
| | 20szt. | | 10szt. |
| | 30szt. | | 10szt. |
| | 30szt. | | 20szt. |
| | 20szt. | | 15szt. |
| | 10szt. | | 15szt. |
| | 20szt. | | 25szt. |
| | 15szt. | | 10szt. |

CODICE	DESCRIZIONE	Q.TÀ
C0420	ASSORTIMENTO CAPICORDA 360PZ	6

Assortimento tubo termoretraibile



- | |
|------------------|
| 40PZ – 2,5X80 mm |
| 32PZ – 3,5X80 mm |
| 24PZ – 5X80 mm |
| 16PZ – 7X80 mm |
| 8PZ – 10X80 mm |
| 8PZ – 13X80 mm |

CODICE	DESCRIZIONE	Q.TÀ
C0418	ASS. TUBO TERMORETRAIBILE 128PZ	6

Assortimento molle



SPINTA:	TIRO:
10PZ. - 5X10 mm	10PZ. - 7X25 mm
10PZ. - 5,5X14 mm	10PZ. - 8X23 mm
10PZ. - 6X10 mm	10PZ. - 7X13 mm
8PZ. - 8X13 mm	10PZ. - 6X12 mm
10PZ. - 7,5X17 mm	10PZ. - 5,5X27 mm
12PZ. - 8,5X26 mm	6PZ. - 9,5X16 mm
12PZ. - 8X50 mm	12PZ. - 9X18 mm
12PZ. - 7X55 mm	8PZ. - 9X35 mm
12PZ. - 4X70 mm	10PZ. - 5,5X38 mm
8PZ. - 5X34 mm	10PZ. - 7X19 mm

CODICE	DESCRIZIONE	Q.TÀ
C0402	ASSORTIMENTO MOLLE 200PZ	6

Assortimento ingrassatori



20 PZ. - M8X1 ANGOLO 180°
15 PZ. - M8X1 ANGOLO 90°
15 PZ. - M8X1 ANGOLO 45°
15 PZ. - M10X1,5 ANGOLO 180°
15 PZ. - M10X1,5 ANGOLO 90°
20 PZ. - M10X1,5 ANGOLO 45°

CODICE	DESCRIZIONE	Q.TÀ
C0407	ASSORTIMENTO INGRASSATORI 100PZ	6

Assortimento coppiglie



150 PZ. - 1,5X25 mm
150 PZ. - 2,5X25 mm
100 PZ. - 2,5X35 mm
75 PZ. - 3X30 mm
50 PZ. - 3X50 mm
30 PZ. - 4X60 mm

CODICE	DESCRIZIONE	Q.TÀ
C0408	ASSORTIMENTO COPPIGLIE 555PZ	6

Assortimento coppiglie grandi



50 PZ. - 3X50 mm
30 PZ. - 4X60 mm
20 PZ. - 5X75 mm
20 PZ. - 6X50 mm
16 PZ. - 6X75 mm
8 PZ. - 8X60 mm

CODICE	DESCRIZIONE	Q.TÀ
C0416	ASSORTIMENTO COPPIGLIE GRANDI 144PZ	6

Assortimento coppiglie a "R"



42 PZ. - 2X30 mm
30 PZ. - 1,6X35 mm
15 PZ. - 1,6X40 mm
25 PZ. - 2,2X42 mm
20 PZ. - 3,2X48 mm
8 PZ. - 3,8X72 mm

CODICE	DESCRIZIONE	Q.TÀ
C0409	ASSORTIMENTO MOLLE 200PZ	6

Assortimento spina a scatto



16 PZ.- 5X36 mm
18 PZ.- 6X45 mm
6 PZ.- 8X45 mm
10 PZ.- 10X45 mm
20 PZ.- 3,2X48 mm

CODICE	DESCRIZIONE	Q.TÀ
C0410	ASSORTIMENTO SPINA A SCATTO 50PZ	6

Assortimento perno / fermo + coppia a "R"



PERNO/FERMO	7 PZ.- 1,98X33,34 mm
5 PZ.- 7,93X50 mm	20 PZ.- 2,78X41,275 mm
18 PZ.- 9,5X50 mm	7 PZ.- 2,78X58,74 mm
5 PZ.- 11,11X63 mm	6 PZ.- 3,57X44,45 mm
3 PZ.- 12,70X50 mm	

CODICE	DESCRIZIONE	Q.TÀ
C0424	ASS. PERNO / FERMO + COPPIGLIA A "R" 71PZ	6

Assortimento perno / fermo



1 PZ.- 10X25 mm
2 PZ.- 10X40 mm
1 PZ.- 10X50 mm
1 PZ.- 8X25 mm
1 PZ.- 8X30 mm
2 PZ.- 8X35 mm
2 PZ.- 8X50 mm
2 PZ.- 8X60 mm
2 PZ.- 8X65 mm
2 PZ.- 8X70 mm
1 PZ.- 6X30 mm
2 PZ.- 6X35 mm
1 PZ.- 6X50 mm

CODICE	DESCRIZIONE	Q.TÀ
C0445	ASSORTIMENTO PERNO / FERMO 20PZ	6

Assortimento spina elastica



30 PZ.- 1,5X8 mm
30 PZ.- 2,5X25 mm
25 PZ.- 2,5X30 mm
30 PZ.- 3X16 mm
20 PZ.- 3X30 mm
20 PZ.- 4X25 mm
25 PZ.- 5X16 mm
20 PZ.- 5X25 mm
10 PZ.- 5,5X45 mm
15 PZ.- 6X16 mm
10 PZ.- 6X30 mm
10 PZ.- 6X45 mm

CODICE	DESCRIZIONE	Q.TÀ
C0419	ASSORTIMENTO SPINA ELASTICA 245PZ	6

Assortimento rondella arresto Benzing



ESTERNO
20 PZ.- 6 mm
20 PZ.- 8 mm
20 PZ.- 9 mm
20 PZ.- 11 mm
20 PZ.- 13 mm
20 PZ.- 14 mm
20 PZ.- 16 mm
20 PZ.- 19 mm
15 PZ.- 20 mm
15 PZ.- 22 mm
15 PZ.- 25 mm
5 PZ.- 32 mm

INTERNO
15 PZ.- 11 mm
15 PZ.- 13 mm
15 PZ.- 14 mm
15 PZ.- 16 mm
15 PZ.- 19 mm
15 PZ.- 20 mm

CODICE	DESCRIZIONE	Q.TÀ
C0401	ASS. RONDELLA ARRESTO BENZING 300PZ	6

Assortimento rondella d'arresto Benzing



30 PZ.- 1/16" / 1,5 mm
30 PZ.- 1/8" / 3 mm
40 PZ.- 3/16" / 5 mm
50 PZ.- 1/4" / 6 mm
50 PZ.- 3/8" / 9,5 mm
40 PZ.- 1/2" / 13 mm
20 PZ.- 5/8" / 16 mm
20 PZ.- 3/4" / 19 mm
20 PZ.- 7/8" / 22 mm

CODICE	DESCRIZIONE	Q.TÀ
C0425	ASS. RONDELLA D'ARRESTO BENZING 300PZ	6

Assortimento rondella rame



30 pz.- 6 mm
25 pz.- 8 mm
20 pz.- 10 mm
15 pz.- 12 mm
10 pz.- 14 mm
10 pz.- 16 mm

CODICE	DESCRIZIONE	Q.TÀ
C0406	ASSORTIMENTO RONDELLA RAME 110PZ	6

Assortimento moschettone a vite



6 pz.- 36x17 mm
4 pz.- 40x20 mm
4 pz.- 49x23 mm
2 pz.- 58x27 mm
2 pz.- 65x31 mm
2 pz.- 75x34 mm

CODICE	DESCRIZIONE	Q.TÀ
C0415	ASSORTIMENTO MOSCHETTONE A VITE 20PZ	6

Assortimento rivetti alluminio



125 pz. - 3,2x11 mm
50 pz. - 4,0x11 mm
50 pz. - 4,8x11 mm
125 pz. - 3,2x17 mm
50 pz. - 4,0x17 mm
50 pz. - 4,8x17 mm

CODICE	DESCRIZIONE	Q.TÀ
C0405	ASSORTIMENTO RIVETTI ALLUMINIO 450PZ	6

Assortimento connettori terminali elettrici



CODICE	DESCRIZIONE	Q.TÀ
YT-06868	ASS. CONNETTORI TERMINALI ELETTRICI 50PZ	6

Set di dadi per filetti rivettati



CODICE	DESCRIZIONE	Q.TÀ
C0449	SET DI DADI PER RIVETTI FILETTATI	300



VITERIA

Vite testa esagonale nylon PA 6.6 DIN 933



CODICE	DESCRIZIONE	Q.TÀ
300933-6X10	M 6X10 mm	200
300933-6X16	M 6X16 mm	200
300933-6X20	M 6X20 mm	200
300933-6X25	M 6X25 mm	200
300933-6X30	M 6X30 mm	200
300933-6X40	M 6X40 mm	200
300933-6X50	M 6X50 mm	200
300933-8X16	M 8X16 mm	200
300933-8X20	M 8X20 mm	200
300933-8X30	M 8X30 mm	200
300933-8X40	M 8X40 mm	200
300933-8X50	M 8X50 mm	100
300933-10X20	M 10X20 mm	100
300933-10X30	M 10X30 mm	100
300933-10X40	M 10X40 mm	100
300933-10X50	M 10X50 mm	100

Rondella nylon DIN 9021 3 volte il foro PA 6.6



CODICE	DESCRIZIONE	Q.TÀ
309021-4X12	Ø 4X12 mm	200
309021-5X15	Ø 5X15 mm	200
309021-6X18	Ø 6X18 mm	200
309021-8X24	Ø 8X24 mm	200
309021-10X30	Ø 10X30 mm	200
309021-12X37	Ø 12X37 mm	200

Barra filettata nylon PA 6.6 DIN 975



CODICE	DESCRIZIONE	Q.TÀ
300975-5X1000	M5	20
300975-6X1000	M6	20
300975-8X1000	M8	20
300975-10X1000	M10	20
300975-12X1000	M12	20

Rondella nylon DIN 125 PA 6.6



CODICE	DESCRIZIONE	Q.TÀ
300125-3	Ø 3 mm	200
300125-4	Ø 4 mm	200
300125-5	Ø 5 mm	200
300125-6	Ø 6 mm	200
300125-8	Ø 8 mm	200
300125-10	Ø 10 mm	200
300125-12	Ø 12 mm	200
300125-14	Ø 14 mm	200
300125-16	Ø 16 mm	100
300125-18	Ø 18 mm	100
300125-20	Ø 20 mm	100
300125-24	Ø 24 mm	50
300125-27	Ø 27 mm	50
300125-30	Ø 30 mm	50

Dado con alette in nylon DIN 315 PA 6.6



CODICE	DESCRIZIONE	Q.TÀ
300315-6	M6	100
300315-8	M8	100
300315-10	M10	100

Dado esagonale in nylon PA6.6 DIN 934



CODICE	DESCRIZIONE	Q.TÀ
30934-3	M3	200
30934-4	M4	200
30934-5	M5	200
30934-6	M6	200
30934-8	M8	200
30934-10	M10	200
30934-12	M12	200

Dado cieco nylon PA6.6 DIN 9010



CODICE	DESCRIZIONE	Q.TÀ
301587-3	M3	100
301587-5	M5	100
301587-6	M6	100
301587-8	M8	100
301587-10	M10	100
301587-12	M12	100

Dado cieco nylon PA6.6 DIN 9010



CODICE	DESCRIZIONE	Q.TÀ
309010-6	M6	100
309010-8	M8	100
309010-10	M10	100

Dado giunzione DIN 6334 ZNC bianca CR3

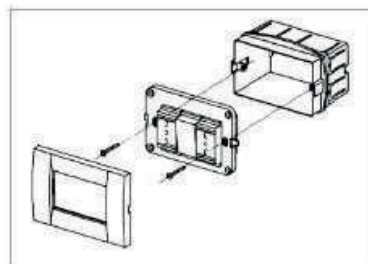

CODICE	DESCRIZIONE	Q.TÀ
3023201X35	D. 3,3x35 mm	200
3023201X50	D. 3,3x50 mm	200
3023201X70	D. 3,3x70 mm	200

Viti per piastra

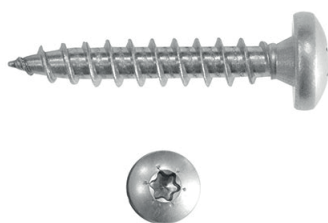

CODICE	DESCRIZIONE	Q.TÀ
303928X40	8X40 mm	250
303928X50	8X50 mm	250
303928X80	8X80 mm	250
3039210X100	10X100 mm	250
3039210X120	10X120 mm	250
3039210X140	10X140 mm	250
3039210X160	10X160 mm	250
3039210X180	10X180 mm	250
3039210X200	10X200 mm	250

Dado giunzione DIN 6334 inox A2

CODICE	DESCRIZIONE	Q.TÀ
1159300-2-5*10	5X10 mm	200
1159300-2-6X30	6X30 mm	100
1159300-2-6*20	6X20 mm	101
1159300-2-8X30	8X30 mm	100
1159300-2-10X30	10X30 mm	100
1159300-2-12X36	12X36 mm	100
1159300-2-16X50	16X50 mm	50

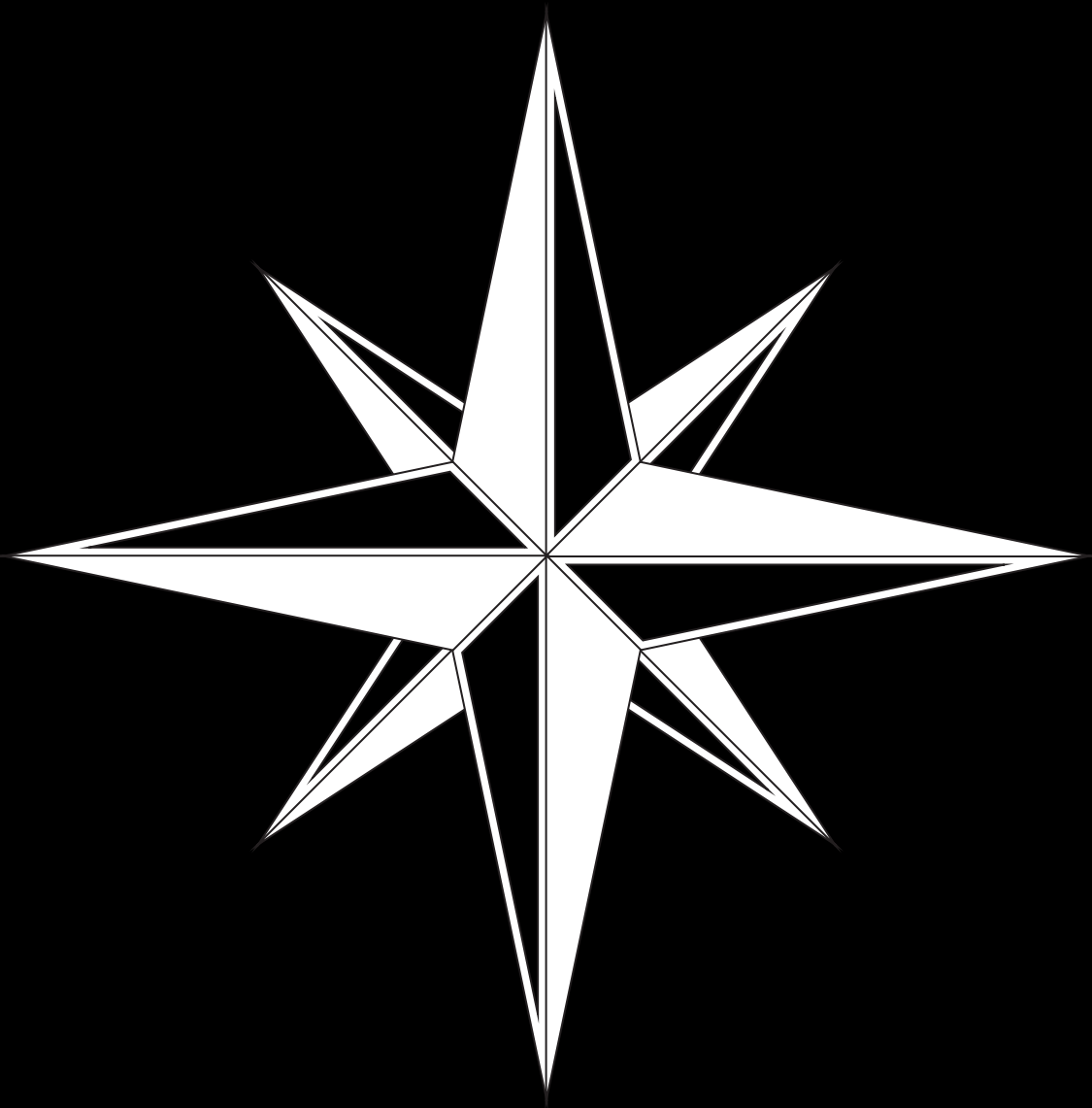

Via Vilfredo Pareto 5
31030 Dosson di Casier (TV) Italy
T. +39 0422331658
F. +39 1782731815
info@bremaksrl.it